



GREENCREATIVE

Brilliant Performance

A track light offering with endless design possibilities





A tailored solution for each application

GREEN CREATIVE knows that good track lighting gives flexibility to lighting designers while remaining understated. That's why we have designed a track lighting family centered around meeting your needs. With field-adjustable lumen outputs, multiple mounting options, a variety of beam angles, and an extensive suite of accessories and lenses, you can be sure that your application is getting the focus it deserves. GREEN CREATIVE also offers its own track system for your new construction or remodel applications.



NOVA

SOL

ATOM
SERIES

ORBIT
SERIES



NOVA WALL WASH TRACK

NOVA

Versatility Meets Wider Horizons

A versatile wall wash track that simplifies specifications by incorporating all settings into a single SKU while ensuring uniform, wide, and precise illumination.



Top-To-Bottom Wide and Uniform Lighting

Designed with cutting-edge optics and a faceted reflector, NOVA provides wide and uniform lighting across expansive surfaces from top to bottom, maximizing the illuminated area with reduced number of fixture installed.

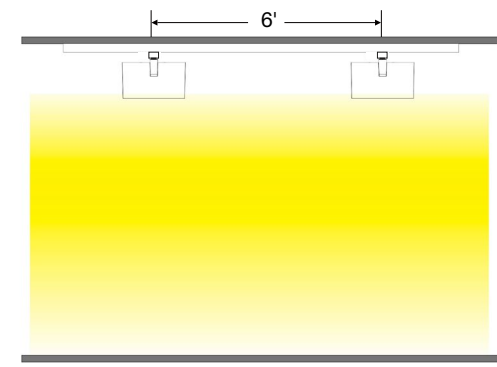
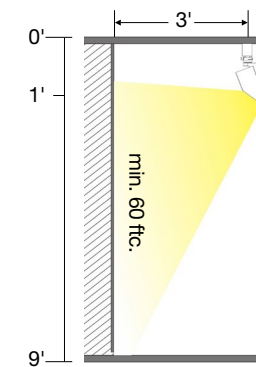

Fewer Head Count, Refine Space

NOVA provides ample and uniform lighting using fewer fixtures due to its broad light distribution and impressive footcandles. With a spacing range of up to 6 feet between fixtures and 3 feet from the wall, your entire area remains brightly illuminated, ensuring a minimum of 60 footcandles on the wall and an even distribution of light from 1 to 9 feet from the ceiling, even between fixtures. Achieve a refined ambiance with a 'silent ceiling' effect, immersing your space with vibrant illumination.

Effortless Field Selectability

Designed with integral power and CCT switches, NOVA allows for field selection of three lumen levels ranging from 3,000lm to 5,000lm with up to 100lm/W efficacy, and three color temperatures from 3000K, 3500K, and 4000K with high CRI 90 for crisp light and superior color accuracy. Specification for right light output and color is at your fingertips directly in the field.

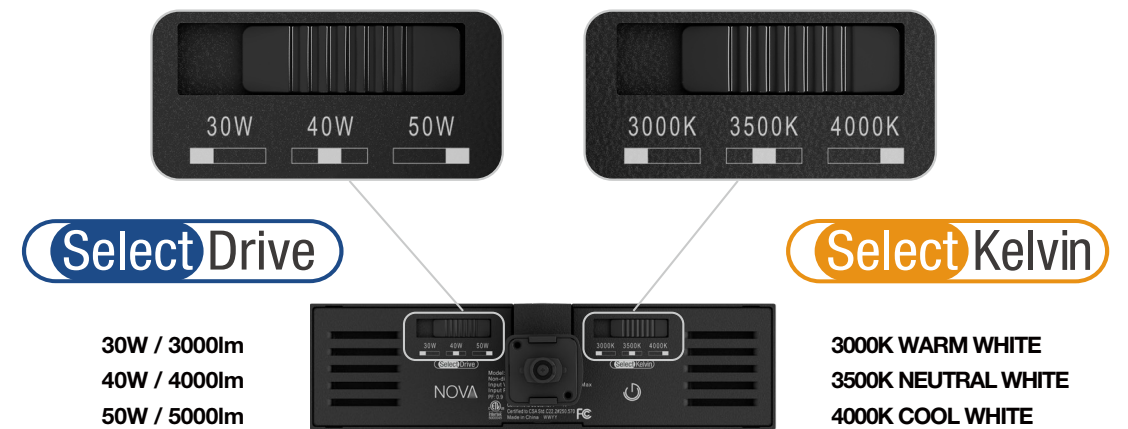

Precise and Convenient Light Adjustment

NOVA is engineered with 360° rotating head and 90° pivot design, with assisting light articulation indicators on the arm of the track head, free and precise aiming of the light towards where needed become a breeze.

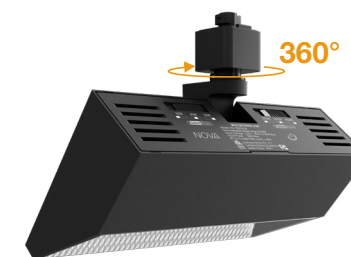



ORBIT TRACK

Unparalleled Flexibility

Compatibility with electrical systems, field-adjustable lumen output technology, and a vast assortment of optical distributions and accessories make the ORBIT a best-in-class track light.

Elegant Design

Available in three sizes with matte white, matte black, or matte silver finishes, the ORBIT integrates smoothly with any décor. This sleek and unobtrusive light lets customers and guests experience a space with no visual disturbance.



Canopy Mount

Flexible Installation

The ORBIT's H, J, and L track head adapters are compatible with most track systems. ETL-listed canopy mounts can be installed on ceilings, walls, or junction boxes, offering design adaptability and consistency.

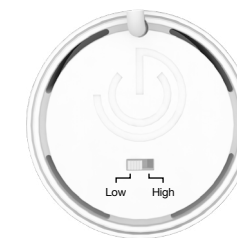

Field-Selectable Output

Each ORBIT track light features our industry-leading SelectDrive technology. With the simple flip of a switch, operators can adjust the lighting layout of their commercial or residential space. This is the perfect solution for customers who want a variety of light levels and applications where dimming systems may not be present.

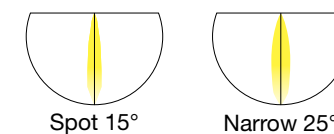

Spot 15°

Narrow 25°

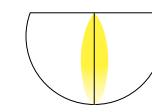

Flood 35°

Multiple Beam Angles

Field interchangeable TIR optics provide three crisp beam angles, allowing for broader design choices. Choose from spot, narrow, or flood distributions to maximize lighting performance no matter the ceiling height or room size.



Full Accessory Suite

Because each application is different, the ORBIT family includes a variety of accessories. Use the wall wash, barn doors, and snoot in conjunction with diffuser lenses to soften, refocus, and control your lighting design. Use the Square lenses for highlighting specific painting or architectural details. Use the CCT shifting lenses for unparalleled warmer colors (2400K and 2200K), creating welcoming environments for your most ambitious project.



ATOM TRACK

Versatile and Compact

With multiple possibilities in color temperature, lumen output, beam angle, fixture color, and mounting, this track fixture can be tailored to any application.

Patented Design

The Atom Track's modular design makes it fully customizable, allowing you to easily make in-field upgrades to the light engine or lens. Snap-on accessories offer additional options, adding flexibility and variety to your lighting project.



Canopy Mount

25° Narrow & 35° Flood beam angles



Matte white & matte black finishes match existing track systems



Track Mount

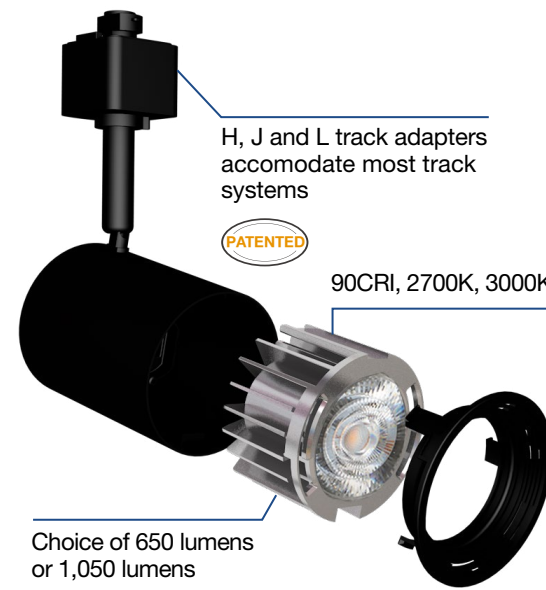

H, J and L track adapters accommodate most track systems



90CRI, 2700K, 3000K, 3500K, 4000K CCT

Choice of 650 lumens or 1,050 lumens



Easy to install snap-on accessories, including wall wash, snoot, honeycomb louver, color shift, CCT shift and square distribution lenses.

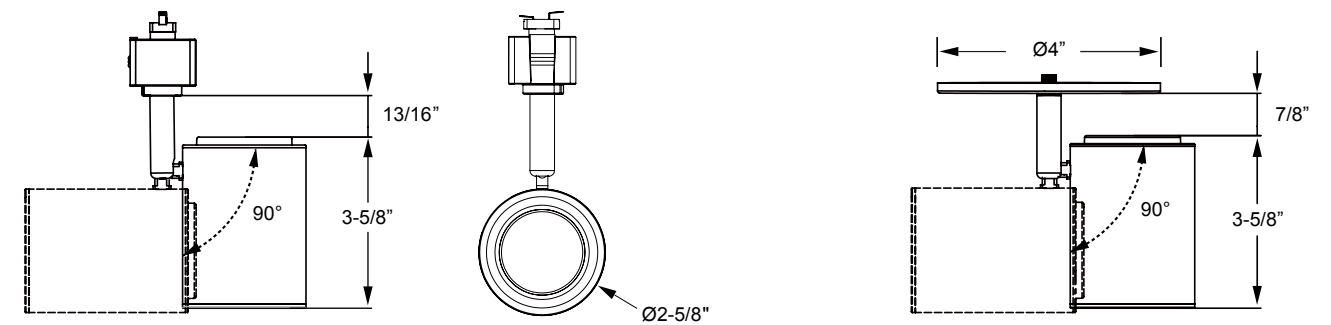



Versatile Track Fixtures Compatible With GREEN CREATIVE PAR Lamps

Designed as the perfect companion with GREEN CREATIVE PAR lamps, the SOL Gimbal Track Head series offers a forward-looking track lighting solution. This series seamlessly integrates a durable track housing with the option for upgrading to retrofit LED PAR lamps.



Versatile Sizes and Finishes

SOL Gimbal Track Head is designed to fit lamps in PAR20, PAR30 short neck and PAR38 form factors. Choose from white or black finishes to effortlessly match your decor style.

The E26 medium screw base design ensures simple installation and removal. It's designed to be future-proof, allowing for upgrades and maintenance, giving you peace of mind that your fixture will endure the test of time.



SOL/GR/PAR20/E26/x/yy
(For PAR20 lamps)



SOL/GR/PAR30/E26/x/yy
(For PAR30 short neck lamps)



SOL/GR/PAR38/E26/x/yy
(For PAR38 lamps)

Maximum Horizontal and Vertical Swivel

Featuring its 2-plane gimbal design, the SOL Gimbal series allows for maximum horizontal and vertical swivel, enabling precise aiming and adding a touch of elegance to any environment.

Equipped with an E26 medium base and compatible with both H-Type and J-Type adapters, it seamlessly integrates with a variety of Track Rails.

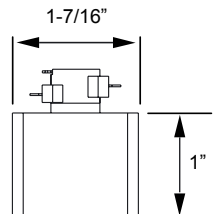

H – Halo Adapter
For single circuit track applications

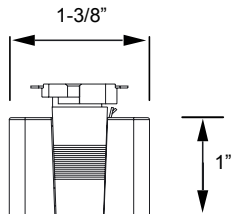

J – Juno Adapter
For single and two-circuit track applications

Perfect Companion with GREEN CREATIVE PAR Lamps

SOL Gimbal Track Heads are designed as perfect companion with GREEN CREATIVE PAR lamps tailored for your specific lighting requirements. REFINE PAR lamps series deliver superior light performance with best color accuracy and efficiency. The AdjustaPAR lamps series offers optimal flexibility for adjusting color temperature and beam angle in the field. Value Select PAR lamps series brings best value solution for everyday contractor projects.

Best Performance



Best Flexibility



Best Value



PUBLIC FACILITIES

- Museums
- Galleries
- Community Centers
- Libraries



RESIDENTIAL

- Kitchens & Dining Rooms
- Living Rooms
- Attics & Cellars
- Home Cinemas

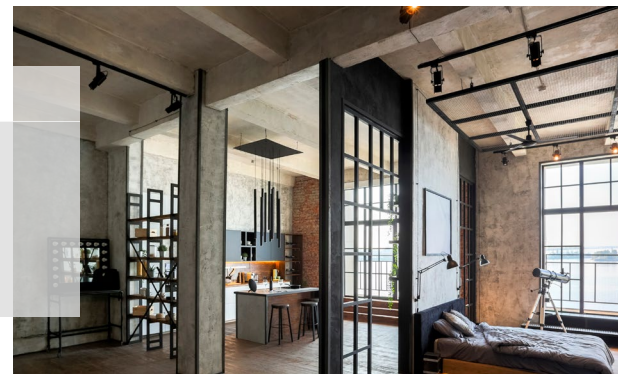







NOVA

SOL

RBIT

ATOM

TRACK LIGHTING SELECTION GUIDE

SELECTION GUIDE					
Size		S (2")	S (2"), M (3"), L (4")	PAR20, PAR30, PAR38	Unique
Application	Retail	●●●	●●●	●●●	●●●
	Residential	●●●	●●●	●●●	●●●
	Hospitality	●●●	●●●	●●●	●●●
	Offices	●●●	●●●	●●●	●●●
	Libraries and Museums	●●●	●●●	●●●	●●●
Specifications	Power	7 / 11W	Selectable 7 / 10W, 15 / 20W, 30 / 40W	6.5W to 15.5W (Depending on PAR lamp)	Selectable 30 / 40 / 50W
	CCT	27K / 30K / 35K / 40K	27K / 30K / 35K / 40K	27K / 30K / 35K / 40K (Depending on PAR lamp)	Selectable 30K / 35K / 40K
	CRI (min.)	90	92	90 or 95 (Depending on PAR lamp)	90
	SDCM LED binning (max.)	3-Steps	2-Steps	3 to 7-Steps (Depending on PAR lamp)	3-Steps
	Lumen @30K	700 / 1100 lm	Selectable 700 / 1000lm, 1500 / 1900lm, 2850 / 3800lm	520 to 1420lm (Depending on PAR lamp)	Selectable 3000 / 4000 / 5000lm
	Efficacy @30K	102 / 98 LPW	100 / 95 / 100 LPW	80 to 100 LPW (Depending on PAR lamp)	100 LPW
	Beam	NR 25°, FL 35°	SP 15°, NR 25°, FL 35°	SP 15°, NR 25°, FL 40°	60° x 90°
	Max CBCP	5300 / 3800	32000 / 21000 / 7900	595 to 14800 (Depending on PAR lamp)	N.A
	Medias	4 (Honey Comb, Square Lenses, CCT Shift Lenses and Color Shift Lenses)	6 (Honey Comb, Linear Spread, Solite, Square and CCT Shift lenses)	N.A	N.A
	Wall Wash	✓	✓	N.A	✓
	Snoot	✓	✓	N.A	N.A
	Barn Door	✓	✓	N.A	N.A
	Track Compatibility	H, J, L	H, J, L	H, J	H, J
	Canopy Mounting	✓	✓	N.A	N.A
	Dimming Type	ELV / Triac	ELV / Triac	ELV / Triac	ELV / Triac
	Dimming Level	Down to 10% (min.)	Down to 5% (min.)	Down to 5% (Depending on PAR lamp)	Down to 10% (min.)
	Listing	ETL Dry	ETL Dry	UL Dry	ETL Dry
	Lifetime	50,000hrs	50,000hrs	25,000 to 50,000hrs	140,000hrs
Warranty	5yrs	5yrs	1yr for the fixture, 3 to 5yrs for the lamps	5yrs	
Rotation	350°	350°	358°	360°	
Tilt	90°	120°	90°	90°	
Special Features	SelectDrive 		✓		✓
	SelectKelvin 				✓
	BAA / TAA 		BAA	TAA	

HOSPITALITY

- Restaurants
- Coffee Shops
- Hotel Lobbies & Dining Areas
- Convention Rooms



RETAIL SPACES

- Clothing Stores
- Furniture Shops
- Designer Spaces
- Showrooms



OFFICES

- Lobbies
- Break Lounges
- Executive Offices
- Foyers
- Conference Rooms
- Open Offices





TRACK SYSTEM

GREEN CREATIVE Track System

GREEN CREATIVE provides the possibility of designing or completely remodeling your space with a comprehensive track system offering and its suite of mounting accessories, to give life to your most audacious design concepts. Whether you need to suspend your light, provide special geometrical layouts, surface mount or even curved designs, we have a solution to complement your space.

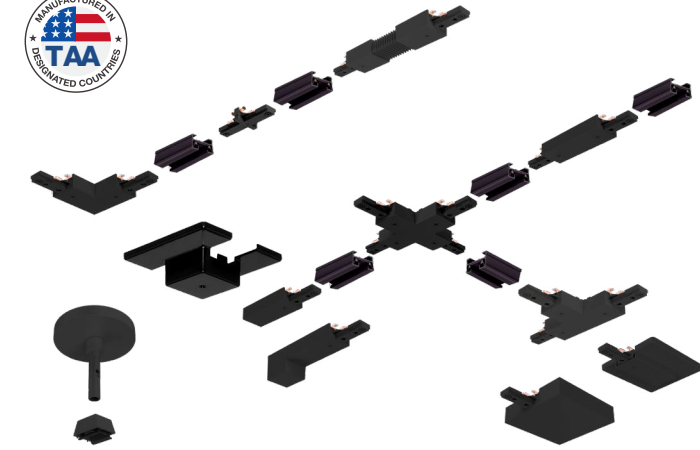

Type	J-Type
Dimensions	1-7/16" x 11/16" I-Beam Style
Finish	White, Black, Silver
Section	24", 48" and 96" (field cuttable)
Electrical Rating	20A at 120V, 60Hz. 2.4 kW Max. Power
Circuit	Single Circuit
Dimming	120V
Surface Mount	✓
Pendant Mount	✓
T-Bar Installation	✓
Fixture Series Compatibility	ATOM, ORBIT, SOL, NOVA

TRACK SYSTEM INSTALLATIONS PROPOSAL (top plan view)

Shaded area: Hot side of track system

: Straight section of track (TRKJ/xx/1C/yy)
 : End Cap of track section (TRKJ/END/1C/yy)

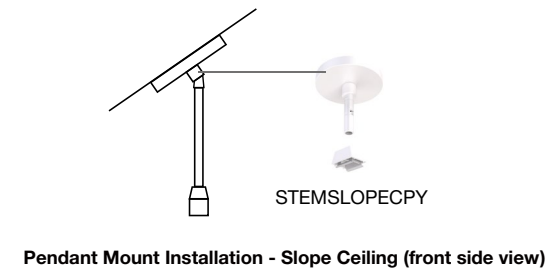
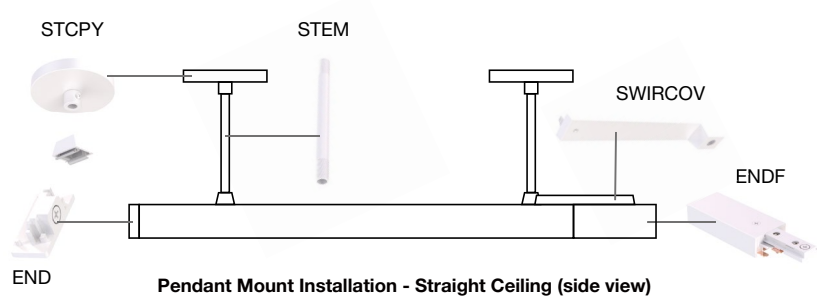
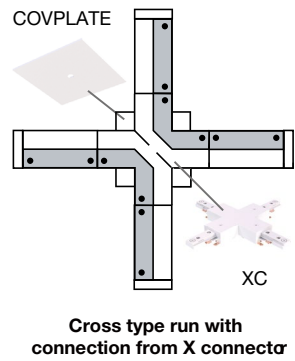
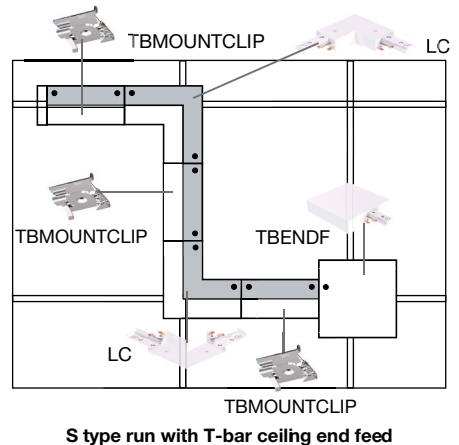
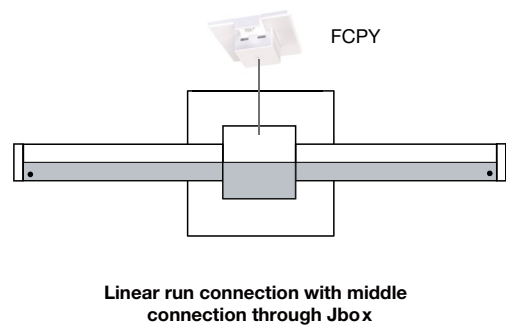
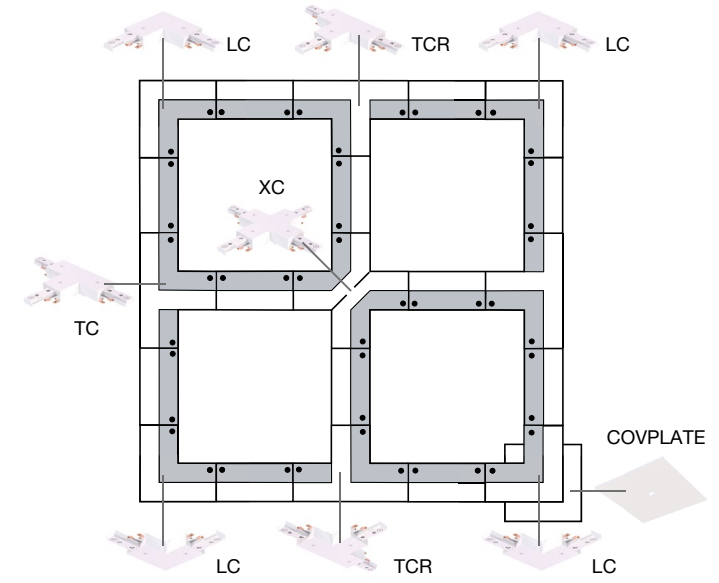
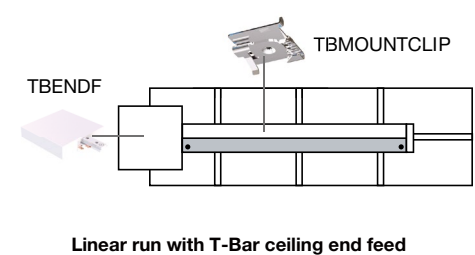
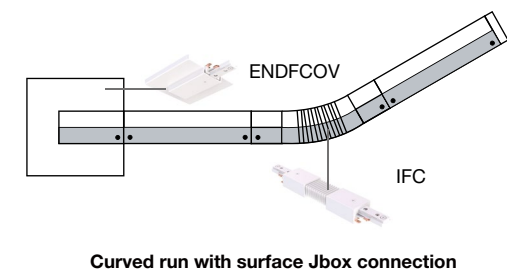
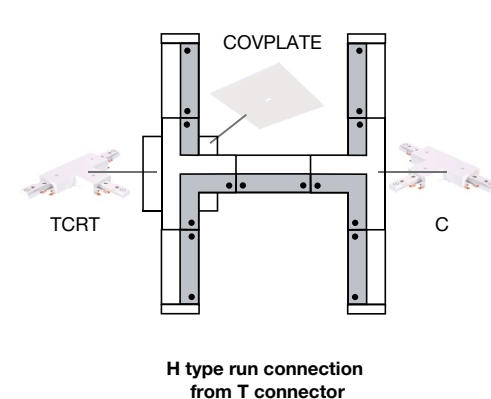
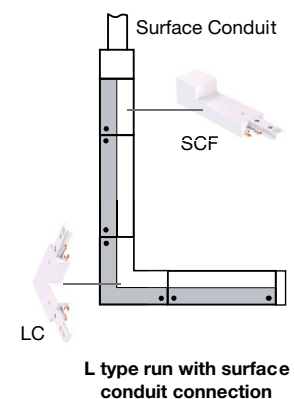
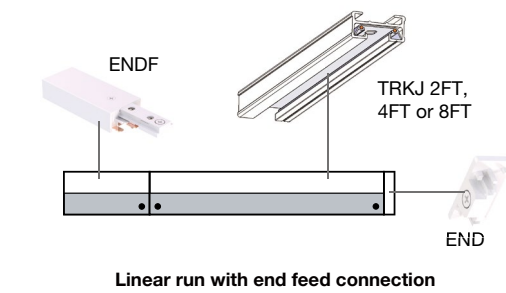



GREENCREATIVE

Your Partner for Professional Lighting Solutions

