

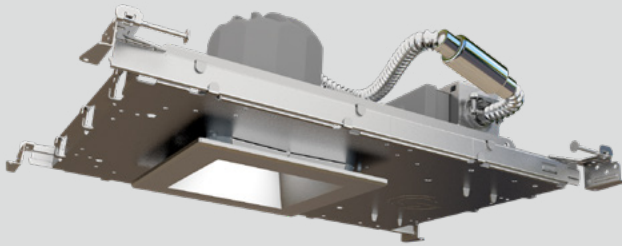

# GREENCREATIVE

Your Partner for Professional Lighting Solutions







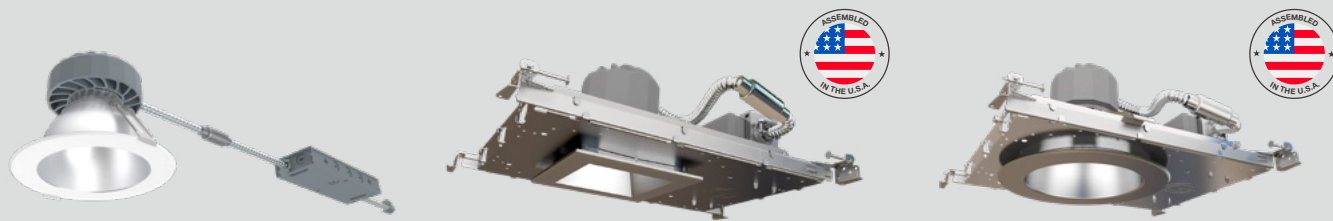

## **SPECFIT COMMERCIAL DOWNLIGHT**

**Specification Grade | Versatile Options | Easy Installation**













## FOR BOTH RETROFIT AND NEW CONSTRUCTIONS

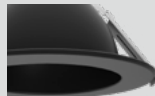

### 3 LIGHT ENGINE SIZE FROM 500 TO 5000LM

 <b>Small</b> 500 / 700 / 1000 Lumens  8'-20' Ceiling	 <b>Medium</b> 1500 / 2000 / 2500 Lumens  20'-30' Ceiling	 <b>Large</b> 3000 / 4000 / 5000 Lumens  30'-40' Ceiling
--	--	---

## REFLECTORS IN VARIOUS SIZES, SHAPES AND COLORS

<b>4"</b> 	<b>6"</b> 	<b>8"</b> 	<b>9.5"</b> 
 <b>CC</b> Clear Diffuse Trim and Flange	 <b>CC</b> Clear Diffuse Trim and Flange	 <b>BL</b> Matte Black Trim and Flange	 <b>BL</b> Matte Black Trim and Flange
 <b>WH</b> Matte White Trim and Flange	 <b>WH</b> Matte White Trim and Flange	 <b>CW</b> Clear Diffuse Trim, White and Flange	 <b>CW</b> Clear Diffuse Trim, White and Flange

## STANDARD DRIVERS

SelectDrive 120V & 0-10V



## DRIVER & CONTROL OPTIONS



## CHOICE OF DIFFERENT BEAM ANGLES

The multiple choice of beam angles thanks to its field interchangeable lenses allow for even more design flexibility. Choose from Very Narrow, Narrow, Medium or Wide optical distributions to maximize the lighting performance of any sized space.

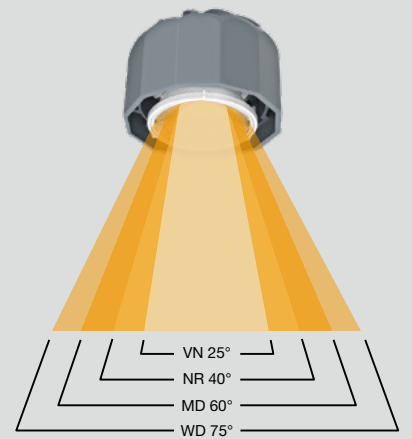

## GLARE FREE OPTICAL CUTOFF

The SpecFit reflectors are designed to minimize aperture brightness and reduce glare for maximum visual comfort in demanding office, healthcare and educational environments. The round and square reflectors provide 45° and 42° optical cutoff respectively, ensuring comfort without sacrificing performance.

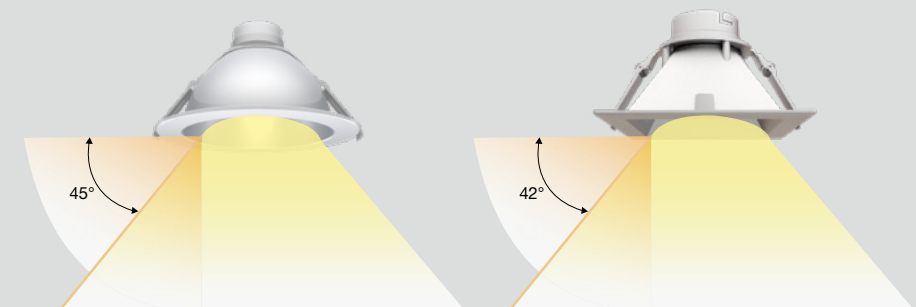

## 5 COLOR TEMPERATURES

The SPECFIT COB LED is binned to 3-step SDCM to ensure color uniformity across the CCT. It comes standard with 90 CRI minimum, and up to 97 CRI with TRUE CHROMA in 3000K.

Day Light 5000K	90+ CRI
Cool White Light 4000K	90+ CRI
Neutral White Light 3500K	90+ CRI
Warm White Light 3000K	97 CRI TRUE CHROMA
Soft White Light 2700K	90+ CRI

## TRUE CHROMA VERSION AVAILABLE FOR 3000K

Rf≥93, CRI≥95, R9≥50, SDCM≤3

SPECFIT, powered by TRUE CHROMA technology, has the highest color accuracy standard in the market. Rest assured that new spaces lit with SPECFIT fixtures powered by TRUE CHROMA will look their best.

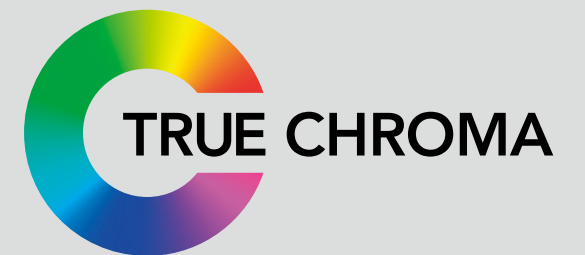



SPECFIT is the ideal choice for a large variety of applications. Whether it is a retrofit, remodel or new construction project, it will accommodate any of your Commercial, Education, Office, Hospitality or Retail projects.



90 CRI COB binned to within 3 SDCM. 97 CRI TRUE CHROMA available in 3000K

Three light engine sizes range from 500 to 5000 lumens

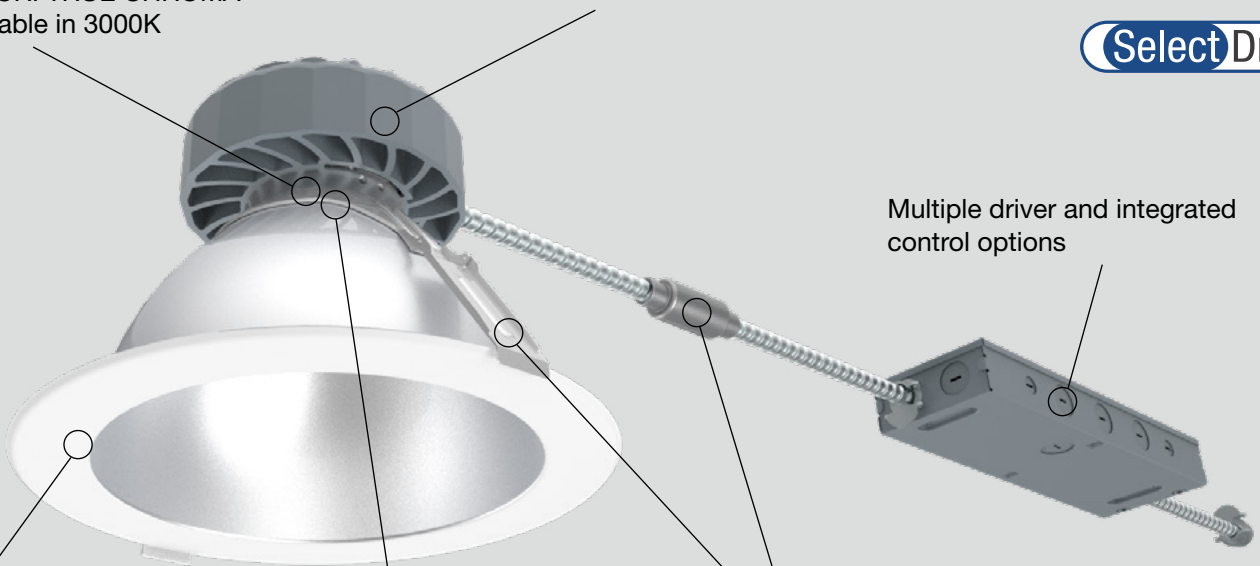

Multiple driver and integrated control options

Deep reflectors, design to maximize comfort and minimize high angle glare

Field interchangeable TIR optical lenses provide precise, consistent beam control

Spring clips and quick connector provide easy, secure installation

