

Project Name:	Type:
Part Number:	Date:



GREENCREATIVE

SPECFIT 6" NEW CONSTRUCTION

SPECIFICATION FEATURES

- Mechanical** - Galvanized steel plaster frame. Low profile bar hangers with non-pass through construction and leveling flanges contain integral tee bar clip and preinstalled nail. Bar hangers are adjustable from 13-1/4" to 24-1/2" and can be installed in suspended T-Grid or wood joist ceilings. Attached junction box with quick connect MC cable allows for easy fixture wiring. The reflector's spring action clips allow for a secure installation in ceilings from 1/2" to 2" thick.
- Electrical** - Two selectable lumen output driver options with SelectDrive technology. The 120V, 50/60 Hz driver is forward or reverse phase dimmable to 5%. The 120-277V, 50/60 Hz driver is 0-10V dimmable to 5% with a low end cutoff and comes with a 12V auxiliary port that provides power for field installed sensors and control modules. Static lumen output driver options include the Lutron 5-Series Ecosystem driver which provides smooth dimming to 5% and the Lutron Hi-Lume 1% EcoSystem driver with Soft-On, Fade-to-Black which dims to 1%. EldoLED ECOdrive and SOLOdrive drivers are available in 0-10V and DALi configurations and dim smoothly to 1% and 0.1% respectively. Enlighted compact sensors and Philips EasySense sensors are field installable and directly integrate with the factory provided Philips Xitanium driver and Sensor Ready Bridge.
- Optical** - Self-flanged spun aluminum reflector. 45° optical cutoff. Field interchangeable optical lenses. Four beam distributions range from 25° - 75°. Wall wash field installed accessory. COB LED binned to 3-step SDCM to ensure color uniformity in 2700K, 3000K, 3500K, 4000K or 5000K CCT. Minimum 90 CRI. 97 CRI with TRUE CHROMA available in 3000K only.
- Thermal** - Die cast heat sink. L70 lifetime of 100,000 hours. Fixture operating temperature: -13°F to +95°F (-25°C to 35°C).
- Compliance and Warranty** - ETL Listed for Damp locations. 5 year parts warranty for complete fixture. Optional 10 Year Extended Warranty available, subject to same terms, conditions and installation requirements as standard 5 Year Warranty.



BENEFITS

- Get the right amount of light with SelectDrive technology
- Fits standard 2x2 & 2x4 T-Grids and up to 24" wood joist spacing
- Multiple reflector finish options facilitate any décor
- Field interchangeable optics ensure smooth light levels
- Large variety of dimming and sensor control options

APPLICATIONS

- Commercial Office
- Hospitality
- Retail
- Educational
- Healthcare

DIMENSIONS

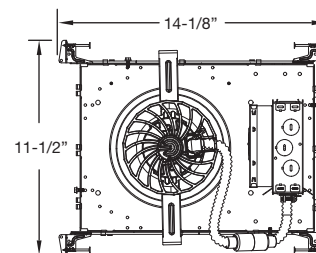
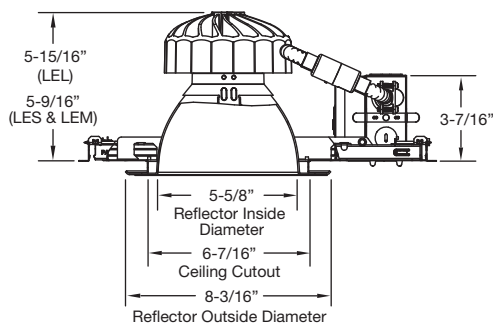



SPECFIT 6" NEW CONSTRUCTION

DIMENSIONS

with / Sensor

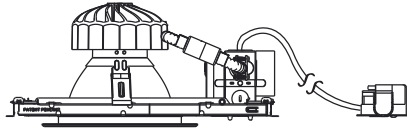

Philips EasySense sensor shown.
Enlighted compact sensor also available.

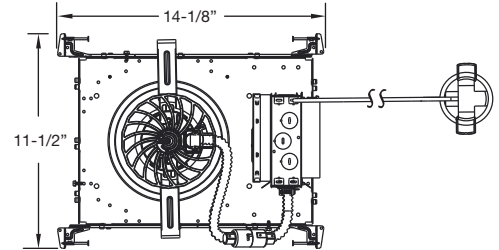

with / EM

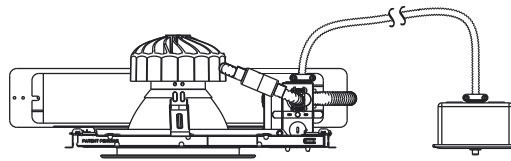

EM Test Switch shown.
Single gang j-box by others.

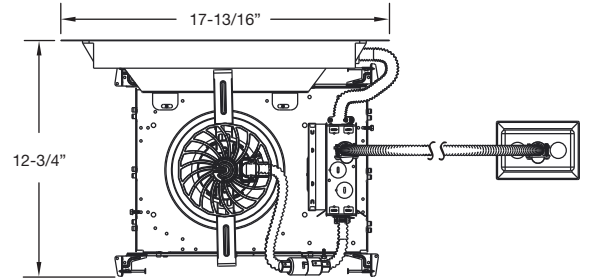

ORDERING EXAMPLE

A complete fixture consists of one light engine and one reflector.

SelectDrive Light Engine: SPFTR6/LEL9035/KDIM010UNV/MD/OUT/EM
Reflector: ADR6CC

SelectDrive Light Engines

Frame Housing	Light Engine	CRI	CCT	Driver	Optical Distribution	Options ⁷
<input type="checkbox"/> SPFTR6 SPECFIT Round New Construction 6"	<input type="checkbox"/> LES Small Light Engine 500-700-1000 lumens	<input type="checkbox"/> 90 90+ CRI	<input type="checkbox"/> 27 2700K	<input type="checkbox"/> KDIM120V SelectDrive 120V, 50/60Hz Forward/Reverse Phase dimming	<input type="checkbox"/> MD¹ Medium (Installed Standard) 60° Beam angle	<input type="checkbox"/> SD347 347V - 240V Step Down Transformer
	<input type="checkbox"/> LEM Medium Light Engine 1500-2000-2500 lumens	<input type="checkbox"/> 97³ 97 CRI 3000K True Chroma	<input type="checkbox"/> 30 3000K	<input type="checkbox"/> KDIM010UNV² SelectDrive 120-277V, 50/60Hz 0-10V dimming	<input type="checkbox"/> VN Very Narrow 25° Beam angle	<input type="checkbox"/> EM⁴ 10W Pre-installed Emergency Backup
	<input type="checkbox"/> LEL Large Light Engine 3000-4000-5000 lumens		<input type="checkbox"/> 35 3500K		<input type="checkbox"/> NR Narrow 40° Beam angle	<input type="checkbox"/> EM⁴-CEC 10W Pre-installed Emergency Backup California Compliant
			<input type="checkbox"/> 40 4000K		<input type="checkbox"/> WD Wide 75° Beam angle	<input type="checkbox"/> OUT Outdoor Debris Ingress Protection
			<input type="checkbox"/> 50 5000K			

Reflectors

Shape	Finish
<input type="checkbox"/> ADR6 6" Round Reflector	<input type="checkbox"/> CC Clear Diffuse Trim and Flange <input type="checkbox"/> WH Matte White Trim and Flange
	<input type="checkbox"/> CW Clear Diffuse Trim, White Flange <input type="checkbox"/> BL Matte Black Trim and Flange

¹ Medium Lens Optic comes installed as standard, if other optic distribution selected the lens will ship separately and require field installation. / ² Dims to 5% with low end cutoff. Dimmer compatibility available on website. / ³ CRI97 TRUE CHROMA is only available in 3000K only and is not Energy Star rated. It is made to order (MTO) for the lumen values of 3000 and above, including the LEL light engine. / ⁴ EM cannot be combined with SD347 or SD480 option / ⁷ Options are factory installed and come with the Light Engine and Driver.



SPECFIT 6" NEW CONSTRUCTION

ORDERING EXAMPLE

A complete fixture consists of one light engine and one reflector.

Philips Light Engine W/ Enlighted Micro Sensor: SPFTR6/LE25/9040/PSRUNV/VN/ENLS-IOT Reflector: ADR6CC	Lutron EcoSystem Light Engine: SPFTR6/LE15/9027/LUT-5UNV/NR Reflector: ADR6BL
Philips Light Engine W/ EasySense Sensor: SPFTR6/LE50/9030/PSRUNV/VN/ES Reflector: ADR6CW	EldoLED Light Engine SOLOdrive: SPFTR6/LE20/9035/ELD-S010UNV/WD Reflector: ADR6WH

ORDERING INFORMATION

Fixed Output Light Engines

Frame Housing	Light Engine	CRI	CCT	Driver	Optical Distribution	Options ⁷
<input type="checkbox"/> SPFTR6 SPECFIT Round New Construction 6"	<input type="checkbox"/> LE05⁸ 500 lumens	<input type="checkbox"/> 90 90+CRI	<input type="checkbox"/> 27 2700K	<input type="checkbox"/> PSRUNV 0-10V Driver + SR Ready Bridge, 120-277V	<input type="checkbox"/> MD¹ Medium (Installed Standard) 60° Beam angle	<input type="checkbox"/> SD347 347V - 240V Step Down Transformer
	<input type="checkbox"/> LE07 700 lumens	<input type="checkbox"/> 97³ 97 CRI 3000K True Chroma	<input type="checkbox"/> 30 3000K	<input type="checkbox"/> LUT-1UNV Lutron EcoSystem 1% Dimming, 120-277V	<input type="checkbox"/> VN Very Narrow 25° Beam angle	<input type="checkbox"/> EM⁴ 10.7W Emergency Backup
	<input type="checkbox"/> LE10 1,000 lumens		<input type="checkbox"/> 35 3500K	<input type="checkbox"/> LUT-5UNV Lutron EcoSystem 5% Dimming, 120-277V	<input type="checkbox"/> NR Narrow 40° Beam angle	<input type="checkbox"/> EM⁴-CEC California Title 20 Compliant 10.7W Emergency Backup
	<input type="checkbox"/> LE15 1,500 lumens		<input type="checkbox"/> 40 4000K	<input type="checkbox"/> LUT-L3DUNV Lutron Hi-Lume 3-Wire 1% Dimming, 120-277V	<input type="checkbox"/> WD Wide 75° Beam angle	<input type="checkbox"/> ES⁵ Philips EasySense ceiling mount sensor
	<input type="checkbox"/> LE20 2,000 lumens		<input type="checkbox"/> 50 5000K	<input type="checkbox"/> ELD-E010UNV EldoLED ECOdrive 0-10V 1%, 120-277V		<input type="checkbox"/> ENLS⁶-IL Enlighted Two Wire ENLIGHTED ONE Compact Sensor
	<input type="checkbox"/> LE25 2,500 lumens			<input type="checkbox"/> ELD-EDALIUNV EldoLED ECOdrive DALI 1%, 120-277V		<input type="checkbox"/> ENLS⁶-CL Enlighted Two Wire CONNECTED LIGHTING Compact Sensor
	<input type="checkbox"/> LE30 3,000 lumens			<input type="checkbox"/> ELD-S010UNV EldoLED SOLOdrive 0-10V 0.1%, 120-277V		<input type="checkbox"/> ENLS⁶-IOT Enlighted Two Wire IOT Compact Sensor
	<input type="checkbox"/> LE40 4,000 lumens			<input type="checkbox"/> ELD-SDALIUNV EldoLED SOLOdrive DALI 0.1%, 120-277V		<input type="checkbox"/> OUT Outdoor Debris Ingress Protection
	<input type="checkbox"/> LE50⁹ 5,000 lumens					

Reflectors

Shape	Finish
<input type="checkbox"/> ADR6 6" Round Reflector	<input type="checkbox"/> CC Clear Diffuse Trim and Flange
	<input type="checkbox"/> WH Matte White Trim and Flange
	<input type="checkbox"/> CW Clear Diffuse Trim, White Flange
	<input type="checkbox"/> BL Matte Black Trim and Flange

¹ Medium Lens Optic comes installed as standard, if other optic distribution selected the lens will ship separately and require field installation / ³ CRI97 TRUE CHROMA is only available in 3000K only and is not Energy Star rated. It is made to order (MTO) for the lumen values of 3000 and above, including the LEL light engine. / ⁴ EM cannot be combined with SD347 or SD480 option / ⁵ Philips EasySense ceiling mounted sensor is only available with the PSRUNV driver / ⁶ Enlighted Two Wire Compact Sensor with ceiling mount is only available with the PSRUNV driver. / ⁷ Options are factory installed and come with the Light Engine and Driver. / ⁸ LE05 is not available with LUT-5UNV / ⁹ LE50 is not available with LUT-5UNV and LUT-1UNV.



SPECFIT 6" NEW CONSTRUCTION

ACCESSORY ORDERING INFORMATION

Product	Model	Description	Pictures	Dimensions
98079	ADWAW	Wall Wash (Field Installed on Lens)		
35126	NCFBFB	Set of Two Field Installable Butterfly Brackets For New Construction Rough-in Frame		
35125	NCFEMB	Field Installable Emergency Bracket For New Construction Rough-in Frame		

10 YEAR EXTENDED WARRANTY

Model	SPFTR6 / LE _{xx} / 10YEARWARRANTY*
<p>*Where xx = Fixture Light Engine lumen output designation. Example: 10 Year Warranty Part Number for SPFTR6/LEM or SPFTR6/LE20 Light engine is SPFT6R6/LEM/10YEARWARRANTY and SPFTR6/LE20/10YEARWARRANTY respectively.</p>	



SPECFIT 6" NEW CONSTRUCTION

TECHNICAL INFORMATION

Light Engine	Input Voltage	Input Frequency	Input Current	Input Power	THD Power	Power Factor
LESXXXX	120 / 277V	50 / 60Hz	0.115 / 0.047A	13W	<20%	>0.9
LEMXXXX	120 / 277V	50 / 60Hz	0.270 / 0.114A	31.5W	<20%	>0.9
LELXXXX	120 / 277V	50 / 60Hz	0.530 / 0.217A	60W	<20%	>0.9
LE05XXXX	120 / 277V	50 / 60Hz	0.056 / 0.024A	6.5W	<20%	>0.9
LE07XXXX	120 / 277V	50 / 60Hz	0.073 / 0.034A	8.5W	<20%	>0.9
LE10XXXX	120 / 277V	50 / 60Hz	0.112 / 0.047A	13W	<20%	>0.9
LE15XXXX	120 / 277V	50 / 60Hz	0.154 / 0.068A	18W	<20%	>0.9
LE20XXXX	120 / 277V	50 / 60Hz	0.218 / 0.092A	25.5W	<20%	>0.9
LE25XXXX	120 / 277V	50 / 60Hz	0.269 / 0.116A	31.5W	<20%	>0.9
LE30XXXX	120 / 277V	50 / 60Hz	0.318 / 0.133A	37.5W	<20%	>0.9
LE40XXXX	120 / 277V	50 / 60Hz	0.411 / 0.165A	48.5W	<20%	>0.9
LE50XXXX	120 / 277V	50 / 60Hz	0.487 / 0.203A	57.5W	<20%	>0.9

NOMINAL PERFORMANCE

LES (LE05 / LE07 / LE10) - Low / Medium / High - 6.5 / 8.5 / 13W

CCT	2700K			3000K			3500K			4000K			5000K		
	Low	Medium	High	Low	Medium	High	Low	Medium	High	Low	Medium	High	Low	Medium	High
Output**	Im LPW	Im LPW	Im LPW	Im LPW	Im LPW	Im LPW	Im LPW	Im LPW	Im LPW	Im LPW	Im LPW	Im LPW	Im LPW	Im LPW	Im LPW
Finish	Im LPW	Im LPW	Im LPW	Im LPW	Im LPW	Im LPW	Im LPW	Im LPW	Im LPW	Im LPW	Im LPW	Im LPW	Im LPW	Im LPW	Im LPW
Clear Diffuse	500 77	700 82	1,000 80	525 81	735 86	1,050 84	550 85	770 91	1,100 88	575 88	805 95	1,150 92	580 89	810 95	1,165 93
White	495 76	693 82	990 79	520 80	728 86	1,040 83	545 84	762 90	1,089 87	569 88	797 94	1,139 91	574 88	802 94	1,153 92
Black	440 68	616 72	880 70	462 71	647 76	924 74	484 74	678 80	968 77	506 78	708 83	1,012 81	510 78	714 84	1,015 81

LEM (LE15 / LE20 / LE25) - Low / Medium / High - 18.0 / 25.5 / 31.5W

CCT	2700K			3000K			3500K			4000K			5000K		
	Low	Medium	High	Low	Medium	High	Low	Medium	High	Low	Medium	High	Low	Medium	High
Output**	Im LPW	Im LPW	Im LPW	Im LPW	Im LPW	Im LPW	Im LPW	Im LPW	Im LPW	Im LPW	Im LPW	Im LPW	Im LPW	Im LPW	Im LPW
Finish	Im LPW	Im LPW	Im LPW	Im LPW	Im LPW	Im LPW	Im LPW	Im LPW	Im LPW	Im LPW	Im LPW	Im LPW	Im LPW	Im LPW	Im LPW
Clear Diffuse	1,600 89	2,125 83	2,500 79	1,632 91	2,169 85	2,550 81	1,664 92	2,210 87	2,600 83	1,696 94	2,253 88	2,650 84	1,713 95	2,275 89	2,677 85
White	1,584 88	2,104 82	2,475 78	1,616 90	2,147 84	2,525 80	1,647 91	2,188 86	2,574 82	1,679 93	2,230 87	2,624 83	1,696 94	2,252 88	2,650 84
Black	1,408 78	1,870 73	2,200 70	1,436 80	1,909 75	2,244 71	1,464 81	1,945 77	2,288 73	1,492 83	1,983 77	2,332 74	1,507 84	2,002 79	2,355 75

LEL (LE30 / LE40 / LE50) - Low / Medium / High - 37.5 / 48.5 / 60.0W

CCT	2700K			3000K			3500K			4000K			5000K		
	Low	Medium	High	Low	Medium	High	Low	Medium	High	Low	Medium	High	Low	Medium	High
Output**	Im LPW	Im LPW	Im LPW	Im LPW	Im LPW	Im LPW	Im LPW	Im LPW	Im LPW	Im LPW	Im LPW	Im LPW	Im LPW	Im LPW	Im LPW
Finish	Im LPW	Im LPW	Im LPW	Im LPW	Im LPW	Im LPW	Im LPW	Im LPW	Im LPW	Im LPW	Im LPW	Im LPW	Im LPW	Im LPW	Im LPW
Clear Diffuse	3,325 89	4,085 84	4,750 79	3,360 90	4,080 84	4,800 80	3,500 93	4,250 88	5,000 83	3,640 97	4,420 91	5,200 87	3,640 97	4,420 91	5,200 87
White	3,292 88	4,044 83	4,703 78	3,326 89	4,039 83	4,752 79	3,465 92	4,208 87	4,950 82	3,604 96	4,376 90	5,148 86	3,604 96	4,376 90	5,148 86
Black	2,826 78	3,472 71	4,038 67	2,856 77	3,468 71	4,080 68	2,975 79	3,613 75	4,250 71	3,094 82	3,757 77	4,420 74	2,829 75	3,757 77	4,420 74

** Lumen output are based on rated lumens, for exact value please refer to the IES files

SPECFIT 6" NEW CONSTRUCTION

PHOTOMETRY

SPFTR6-LES9035-KDIM010-UNV-VN-ADR6CC

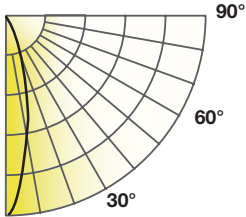

Lumens: 1,236 lm
 Power: 12.7 W
 Efficacy: 98 lm/W
 CRI: 90+
 Spacing Criteria: 0.4
 Beam Angle: 25°

Candlepower Distribution		Initial Footcandles			Zonal Lumen Summary		
Angle (°)	Average (cd)	Height (ft)	Fc	Diameter (ft)	Zone	Lumens	%Fixt
10	2,603	4	278	2	0-30	1,139	93%
20	1,157	6	123	3	0-40	1,214	98%
30	293	8	69	4	0-60	1,234	100%
40	40	10	44	5	0-90	1,236	100%
50	6	12	31	5			
60	2						
70	1						
80	0						
90	0						

SPFTR6-LES9035-KDIM010-UNV-NR-ADR6CC

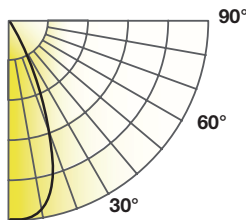

Lumens: 1,234 lm
 Power: 12.5 W
 Efficacy: 99 lm/W
 CRI: 90+
 Spacing Criteria: 0.7
 Beam Angle: 43°

Candlepower Distribution		Initial Footcandles			Zonal Lumen Summary		
Angle (°)	Average (cd)	Height (ft)	Fc	Diameter (ft)	Zone	Lumens	%Fixt
10	2,233	4	141	3	0-30	1,111	93%
20	1,401	6	63	5	0-40	1,217	98%
30	456	8	35	6	0-60	1,233	100%
40	46	10	23	8	0-90	1,234	100%
50	5	12	16	9			
60	2						
70	1						
80	0						
90	0						

SPFTR6-LES9035-KDIM010-UNV-MD-ADR6CC

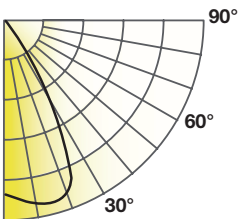

Lumens: 1,240 lm
 Power: 12.2 W
 Efficacy: 102 lm/W
 CRI: 90+
 Spacing Criteria: 0.9
 Beam Angle: 64°

Candlepower Distribution		Initial Footcandles			Zonal Lumen Summary		
Angle (°)	Average (cd)	Height (ft)	Fc	Diameter (ft)	Zone	Lumens	%Fixt
10	1,317	8	80	4	0-30	965	74%
20	1,277	10	36	7	0-40	1,203	95%
30	755	12	20	9	0-60	1,237	100%
40	168	15	13	11	0-90	1,240	100%
50	8	20	9	13			
60	2						
70	1						
80	0						
90	0						



SPECFIT 6" NEW CONSTRUCTION

PHOTOMETRY

SPFTR6-LES9035-KDIM010-UNV-WD-ADR6CC

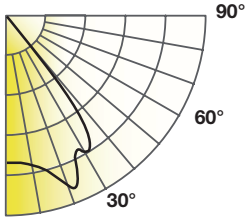

Lumens: 1,257 lm
 Power: 12.28 W
 Efficacy: 102.33 lm/W
 CRI: 90+
 Spacing Criteria: 1.2
 Beam Angle: 43.3°

Candlepower Distribution		Initial Footcandles			Zonal Lumen Summary		
Angle (°)	Average (cd)	Height (ft)	Fc	Diameter (ft)	Zone	Lumens	%Fixt
10	1,153	4	56	6	0-30	663	53%
20	1,238	6	25	9	0-40	1120	89%
30	704	8	14	13	0-60	1251	100%
40	137	10	9	16	0-90	1257	100%
50	26	12	6	19			
60	6						
70	2						
80	0						
90	0						

SPFTR6-LEM9035-KDIM010-UNV-VN-ADR6CC

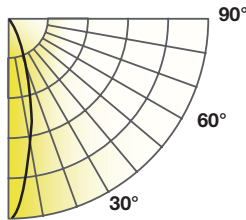

Lumens: 2,555 lm
 Power: 30.9 W
 Efficacy: 83 lm/W
 CRI: 90+
 Spacing Criteria: 0.4
 Beam Angle: 25°

Candlepower Distribution		Initial Footcandles			Zonal Lumen Summary		
Angle (°)	Average (cd)	Height (ft)	Fc	Diameter (ft)	Zone	Lumens	%Fixt
10	5,592	4	607	2	0-30	2,364	93%
20	2,178	6	270	3	0-40	2,510	98%
30	635	8	152	3	0-60	2,539	100%
40	88	10	97	4	0-90	2,555	100%
50	12	12	67	5			
60	4						
70	1						
80	0						
90	0						

SPFTR6-LEM9035-KDIM010-UNV-NR-ADR6CC

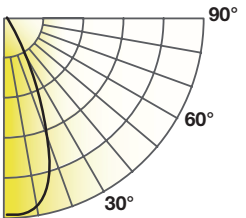

Lumens: 2,567 lm
 Power: 31.1 W
 Efficacy: 83 lm/W
 CRI: 90+
 Spacing Criteria: 0.7
 Beam Angle: 41°

Candlepower Distribution		Initial Footcandles			Zonal Lumen Summary		
Angle (°)	Average (cd)	Height (ft)	Fc	Diameter (ft)	Zone	Lumens	%Fixt
10	4,978	8	302	3	0-30	2,332	91%
20	2,529	10	134	5	0-40	2,532	99%
30	920	12	76	6	0-60	2,562	100%
40	86	15	48	7	0-90	2,567	100%
50	11	20	34	9			
60	3						
70	1						
80	0						
90	0						

SPECFIT 6" NEW CONSTRUCTION

PHOTOMETRY

SPFTR6-LEM9035-KDIM010-UNV-MD-ADR6CC

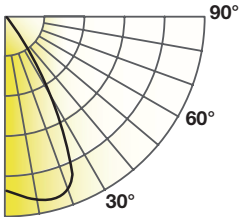

Lumens: 2,532 lm
 Power: 30.9 W
 Efficacy: 82 lm/W
 CRI: 90+
 Spacing Criteria: 0.9
 Beam Angle: 65°

Candlepower Distribution		Initial Footcandles			Zonal Lumen Summary		
Angle (°)	Average (cd)	Height (ft)	Fc	Diameter (ft)	Zone	Lumens	%Fixt
10	2,493	4	164	4	0-30	1,957	77%
20	2,839	6	73	6	0-40	2,460	97%
30	1,555	8	41	8	0-60	2,526	100%
40	232	10	26	11	0-90	2,532	100%
50	13	12	18	13			
60	4						
70	2						
80	0						
90	0						

SPFTR6-LEM9035-KDIM010-UNV-WD-ADR6CC

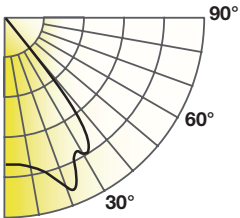

Lumens: 2,555 lm
 Power: 31.0 W
 Efficacy: 82 lm/W
 CRI: 90+
 Spacing Criteria: 1.2
 Beam Angle: 83°

Candlepower Distribution		Initial Footcandles			Zonal Lumen Summary		
Angle (°)	Average (cd)	Height (ft)	Fc	Diameter (ft)	Zone	Lumens	%Fixt
10	1,508	4	113	6	0-30	1,289	50%
20	1,366	6	50	9	0-40	2,261	89%
30	2,064	8	28	13	0-60	2,543	100%
40	1,066	10	18	16	0-90	2,555	100%
50	45	12	13	19			
60	13						
70	5						
80	2						
90	0						

SPFTR6-LEL9035-KDIM010-UNV-VN-ADR6CC

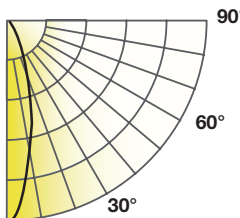

Lumens: 4,709 lm
 Power: 60.7 W
 Efficacy: 78 lm/W
 CRI: 90+
 Spacing Criteria: 0.5
 Beam Angle: 33°

Candlepower Distribution		Initial Footcandles			Zonal Lumen Summary		
Angle (°)	Average (cd)	Height (ft)	Fc	Diameter (ft)	Zone	Lumens	%Fixt
10	813	8	176	5	0-30	4,118	88%
20	478	10	113	6	0-40	4,566	97%
30	204	12	78	7	0-60	4,687	100%
40	26	15	50	9	0-90	4,709	100%
50	5	20	28	12			
60	2						
70	1						
80	0						
90	0						



SPECFIT 6" NEW CONSTRUCTION

PHOTOMETRY

SPFTR6-LEL9035-KDIM010-UNV-NR-ADR6CC

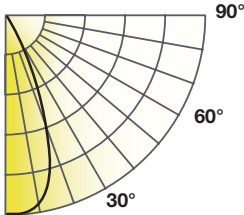

Lumens: 4,874 lm
 Power: 61.1 W
 Efficacy: 80 lm/W
 CRI: 90+
 Spacing Criteria: 0.7
 Beam Angle: 44°

Candlepower Distribution		Initial Footcandles			Zonal Lumen Summary		
Angle (°)	Average (cd)	Height (ft)	Fc	Diameter (ft)	Zone	Lumens	%Fixt
10	7,615	8	145	7	0-30	4,182	86%
20	5,149	10	93	8	0-40	4,780	98%
30	2,134	12	64	10	0-60	4,858	100%
40	223	15	41	12	0-90	4,874	100%
50	33	20	23	16			
60	11						
70	5						
80	2						
90	0						

SPFTR6-LEL9035-KDIM010-UNV-MD-ADR6CC

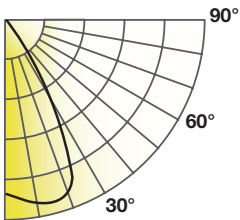

Lumens: 5,017 lm
 Power: 60.59 W
 Efficacy: 82.80 lm/W
 CRI: 90+
 Spacing Criteria: 0.78
 Beam Angle: 54.7°

Candlepower Distribution		Initial Footcandles			Zonal Lumen Summary		
Angle (°)	Average (cd)	Height (ft)	Fc	Diameter (ft)	Zone	Lumens	%Fixt
10	5,967	4	105	8	0-30	3,691	74%
20	4,373	6	67	10	0-40	4,850	97%
30	3,080	8	47	12	0-60	5,000	100%
40	872	10	30	15	0-90	5,017	100%
50	41	12	17	20			
60	13						
70	5						
80	2						
90	0						

SPFTR6-LEL9035-KDIM010-UNV-WD-ADR6CC

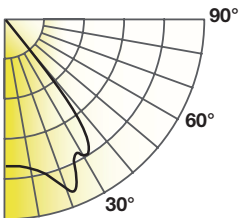

Lumens: 5,068 lm
 Power: 60.6 W
 Efficacy: 83 lm/W
 CRI: 90+
 Spacing Criteria: 1.1
 Beam Angle: 74°

Candlepower Distribution		Initial Footcandles			Zonal Lumen Summary		
Angle (°)	Average (cd)	Height (ft)	Fc	Diameter (ft)	Zone	Lumens	%Fixt
10	3,860	8	63	12	0-30	3,107	61%
20	3,786	10	40	15	0-40	4,612	91%
30	3,355	12	28	18	0-60	5,038	99%
40	1,658	15	18	23	0-90	5,068	100%
50	99	20	10	30			
60	30						
70	12						
80	5						
90	0						

SPECFIT 6" NEW CONSTRUCTION

PHOTOMETRY - TRUE CHROMA

SPFTR6-LES9730-KDIM010-UNV-MD-ADR6CC

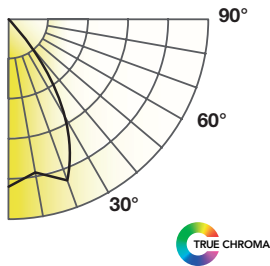

Lumens: 1,061 lm
 Power: 13 W
 Efficacy: 84 lm/W
 CRI: 96
 Spacing Criteria: 1.07
 Beam Angle: 65°

Candlepower Distribution		Initial Footcandles			Zonal Lumen Summary		
Angle (°)	Average (cd)	Height (ft)	Fc	Diameter (ft)	Zone	Lumens	%Fixt
10	1,012	4	94	5	0-30	761	72%
20	978	6	42	8	0-40	1,012	95%
30	643	8	24	10	0-60	1,061	100%
40	172	10	15	13	0-90	1,061	100%
50	5	12	10	15			
60	0						
70	0						
80	0						
90	0						

SPFTR6-LEM9730-KDIM010-UNV-MD-ADR6CC

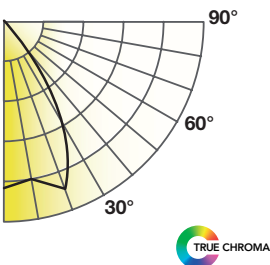

Lumens: 2,231 lm
 Power: 33 W
 Efficacy: 68 lm/W
 CRI: 96
 Spacing Criteria: 1.07
 Beam Angle: 65°

Candlepower Distribution		Initial Footcandles			Zonal Lumen Summary		
Angle (°)	Average (cd)	Height (ft)	Fc	Diameter (ft)	Zone	Lumens	%Fixt
10	2,129	4	198	5	0-30	1,595	72%
20	2,057	6	88	8	0-40	2,122	95%
30	1,357	8	49	10	0-60	2,229	100%
40	366	10	32	13	0-90	1,160	100%
50	8	12	22	15			
60	2						
70	0						
80	0						
90	0						

SPFTR6-LEL9730-KDIM010UNV-MD-ADR6CC

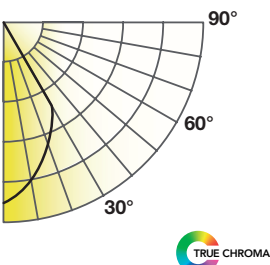

Lumens: 4,230 lm
 Power: 60W
 Efficacy: 71 lm/W
 CRI: 98
 Spacing Criteria: 0.79
 Beam Angle: 57°

Candlepower Distribution		Initial Footcandles			Zonal Lumen Summary		
Angle (°)	Average (cd)	Height (ft)	Fc	Diameter (ft)	Zone	Lumens	%Fixt
10	2,129	8	49	9	0-30	2,963	71%
20	2,057	10	32	11	0-40	4,027	95%
30	1,357	12	22	13	0-60	4,230	100%
40	366	15	14	16	0-90	4,230	100%
50	8	20	8	22			
60	2						
70	0						
80	0						
90	0						