

Project Name:	Type:
Part Number:	Date:

SPECFIT 8"

SPECIFICATION FEATURES

- **Mechanical** - SPECFIT retrofits existing commercial housings. Spring action clips to accommodate ½" to 2" ceiling thicknesses. Fixture with remote driver installs and is accessible from below the ceiling.
- **Electrical** - Standard driver option is 120-277V, 50/60 Hz with three selectable lumen outputs using SelectDrive technology. 0-10V dimmable to 5% with low end cutoff. 12V auxiliary port with stand by power functionality for additional dimming and control of field installed sensors and control systems. Additional driver selections include a 120V line voltage forward and reverse phase dimming option down to 5%, Lutron Ecosystem 5% and 1% dimming driver options and a Philips EasySense sensor compatible driver option.
- **Optical** - Self flanged spun aluminum reflector. 45° optical cutoff. Field interchangeable optical lenses. Four beam distributions. Wall wash field installed accessory. COB LED binned to 3-step SDCM to ensure color uniformity in 2700K, 3000K, 3500K, 4000K or 5000K CCT. Minimum 90 CRI. 97 CRI available in 3000K only.
- **Thermal** - Die cast heat sink. L70 lifetime of 100,000 hours. Fixture operating temperature: -13°F to +95°F (-25°C to 35°C).
- **Compliance and Warranty** - ETL Classified and Listed for damp locations. Suitable for exterior under canopy mounting when utilizing OUT Outdoor Debris Ingress Protection option. 5 year parts warranty for complete fixture. Optional 10 Year Extended Warranty available, subject to same terms, conditions and installation requirements as standard 5 Year Warranty.



032521



BENEFITS

- Get the right amount of light with SelectDrive technology
- Match ceiling décor with field interchangeable trims
- Direct the light with field interchangeable optics
- Various dimming driver options allow for control and energy savings
- Long 100,000 hours L70 rated lifetime
- Exceptional color rendering and uniformity

APPLICATIONS

- Commercial Office
- Hospitality
- Retail
- Educational
- Healthcare
- Exterior Under Canopy*

*Applicable with OUT Outdoor Debris Ingress Protection option.

DIMENSIONS

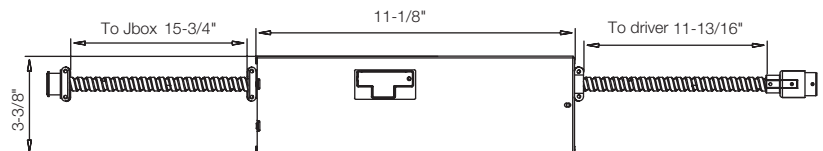
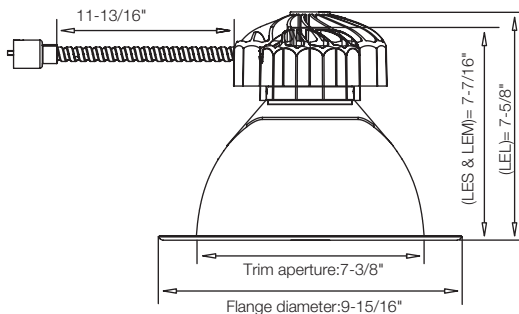

Minimum Ceiling Opening: 7-5/8" Maximum Ceiling Opening: 9-3/16"



SPECFIT 8"

ORDERING EXAMPLE

A complete fixture consists of one light engine and one reflector.

SelectDrive Light Engine: LEM9040DIM010UNVMD
Reflector: ADR8CC

SelectDrive Light Engines

Light Engine	CRI	CCT	Driver	Optical Distribution	Options ⁷
<input type="checkbox"/> LES Small Light Engine 500-700-1,000 lumens	<input type="checkbox"/> 90 90+CRI	<input type="checkbox"/> 27 2700K	<input type="checkbox"/> DIM010UNV² SelectDrive 120-277V, 50/60Hz 0-10V Dimmable to 5%	<input type="checkbox"/> MD¹ Medium (Installed Standard) 60° Beam angle	<input type="checkbox"/> SD347 347V - 240V Step Down Transformer
<input type="checkbox"/> LEM Medium Light Engine 1,500-2,000-2,500 lumens	<input type="checkbox"/> 97³ 97 CRI 3000K only	<input type="checkbox"/> 30 3000K		<input type="checkbox"/> VN Very Narrow 25° Beam angle	<input type="checkbox"/> SD480 480V - 240V Step Down Transformer
<input type="checkbox"/> LEL Large Light Engine 3,000-4,000-5,000 lumens		<input type="checkbox"/> 35 3500K		<input type="checkbox"/> NR Narrow 40° Beam angle	<input type="checkbox"/> EM⁴ Emergency Backup
		<input type="checkbox"/> 40 4000K		<input type="checkbox"/> WD Wide 75° Beam angle	<input type="checkbox"/> EM⁴ -CEC California Title 20 Compliant 10.7W Emergency Backup
		<input type="checkbox"/> 50 5000K			<input type="checkbox"/> OUT Outdoor Debris Ingress Protection

Reflectors

Shape	Finish
<input type="checkbox"/> ADR8 8" Round Reflector	<input type="checkbox"/> CC Clear Diffuse Trim and Flange <input type="checkbox"/> WH Matte White Trim and Flange
	<input type="checkbox"/> CW Clear Diffuse Trim, White Flange

¹ Medium Lens Optic comes installed as standard, if other optic distribution selected the lens will ship separately and require field installation. / ² Dims to 5% with low end cutoff. Dimmer compatibility available on website. / ³ CRI97 TRUE CHROMA is only available in 3000K only and is not Energy Star rated. It is made to order (MTO) for the lumen values of 3000 and above, including the LEL light engine. / ⁴ EM cannot be combined with SD347 or SD480 option / ⁷ Options are factory installed and come with the Light Engine and Driver.



SPECFIT 8"

ORDERING EXAMPLE

A complete fixture consists of one light engine and one reflector.

Philips Light Engine W/ Enlighted Micro Sensor: Reflector:	LE259040PSRUNVWNENLS-IOT ADR8CC	Philips Light Engine W/ EasySense Sensor: Reflector:	LE509030PSRUNVNES ADR8CW
120V Light Engine: Reflector:	LE209035DIM120VWD ADR8BL	Lutron EcoSystem Light Engine: Reflector:	LE159027LUT5UNVNR ADR8WH

ORDERING INFORMATION

Fixed Output Light Engines

Light Engine	CRI	CCT	Driver	Optical Distribution	Options ⁷
<input type="checkbox"/> LE05⁸ 500 lumens	<input type="checkbox"/> 90 90+CRI	<input type="checkbox"/> 27 2700K	<input type="checkbox"/> DIM120V 120V Dimmable, 120V	<input type="checkbox"/> MD¹ Medium (Installed Standard) 60° Beam angle	<input type="checkbox"/> SD347 347V - 240V Step Down Transformer
<input type="checkbox"/> LE07 700 lumens	<input type="checkbox"/> 97³ 97 CRI 3000K only	<input type="checkbox"/> 30 3000K	<input type="checkbox"/> PSRUNV 0-10V Driver + SR Ready Bridge, 120-277V	<input type="checkbox"/> VN Very Narrow 25° Beam angle	<input type="checkbox"/> SD480 480V - 240V Step Down Transformer
<input type="checkbox"/> LE10 1,000 lumens		<input type="checkbox"/> 35 3500K	<input type="checkbox"/> XT010UNV Signify 0-10V Driver 1% Dimming, 120-277V	<input type="checkbox"/> NR Narrow 40° Beam angle	<input type="checkbox"/> EM⁴ 10.7W Emergency Backup
<input type="checkbox"/> LE15 1,500 lumens		<input type="checkbox"/> 40 4000K	<input type="checkbox"/> LUT-1UNV Lutron EcoSystem 1% Dimming, 120-277V	<input type="checkbox"/> WD Wide 75° Beam angle	<input type="checkbox"/> EM⁴-CEC California Title 20 Compliant 10.7W Emergency Backup
<input type="checkbox"/> LE20 2,000 lumens		<input type="checkbox"/> 50 5000K	<input type="checkbox"/> LUT-5UNV Lutron EcoSystem 5% Dimming, 120-277V		<input type="checkbox"/> ES⁵ Philips EasySense ceiling mount sensor
<input type="checkbox"/> LE25 2,500 lumens			<input type="checkbox"/> LUT-L3DUNV Lutron Hi-lume 3-Wire 1% Dimming, 120-277V		<input type="checkbox"/> ENLS⁶-IL Enlighted Two Wire ENLIGHTED ONE Compact Sensor
<input type="checkbox"/> LE30 3,000 lumens			<input type="checkbox"/> ELD-E010UNV EldoLED ECOdrive 0-10V 1%, 120-277V		<input type="checkbox"/> ENLS⁶-CL Enlighted Two Wire CONNECTED LIGHTING Compact Sensor
<input type="checkbox"/> LE40 4,000 lumens			<input type="checkbox"/> ELD-EDALIUNV EldoLED ECOdrive DALI 1%, 120-277V		<input type="checkbox"/> ENLS⁶-IOT Enlighted Two Wire IOT Compact Sensor
<input type="checkbox"/> LE50⁹ 5,000 lumens			<input type="checkbox"/> ELD-S010UNV EldoLED SOLOdrive 0-10V 0.1%, 120-277V		<input type="checkbox"/> OUT Outdoor Debris Ingress Protection
			<input type="checkbox"/> ELD-SDALIUNV EldoLED SOLOdrive DALI 0.1%, 120-277V		





Reflectors

Shape	Finish
<input type="checkbox"/> ADR8 8" Round Reflector	<input type="checkbox"/> CC Clear Diffuse Trim and Flange <input type="checkbox"/> WH Matte White Trim and Flange
	<input type="checkbox"/> CW Clear Diffuse Trim, White Flange

¹ Medium Lens Optic comes installed as standard, if other optic distribution selected the lens will ship separately and require field installation / ³ CRI97 TRUE CHROMA is only available in 3000K only and is not Energy Star rated. It is made to order (MTO) for the lumen values of 3000 and above, including the LEL light engine. / ⁴ EM cannot be combined with SD347 or SD480 option / ⁵ Philips EasySense ceiling mounted sensor is only available with the PSRUNV driver / ⁶ Enlighted Two Wire Compact Sensor with ceiling mount is only available with the PSRUNV driver. / ⁷ Options are factory installed and come with the Light Engine and Driver. / ⁸ LE05 is not available with LUT-5UNV / ⁹ LE50 is not available with LUT-5UNV and LUT-1UNV.

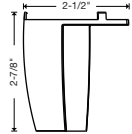

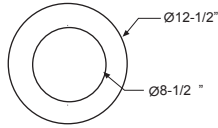
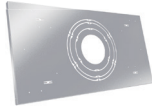
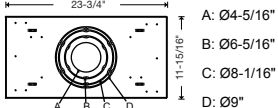
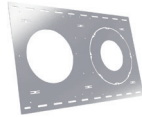
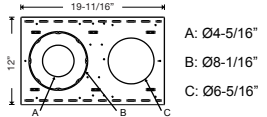
SPECFIT 8"

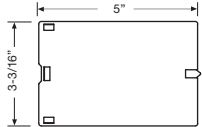
ACCESSORY ORDERING INFORMATION				
Product	Model	Description	Pictures	Dimensions
98079	ADWAW	Wall Wash (Field Installed on Module)		
98567	GOOFRING8	8" Goof Ring - Outer Diameter 12-1/2"		
98501	NCPLATE/T4689	New Construction Plate for T-Grid ceilings		
98502	NCPLATE468	New Construction Plate for Stud/Joist ceilings		
98583	NCPLATEJB	Junction box for New Construction Plates		

10 YEAR EXTENDED WARRANTY

Model	LExx/10YEARWARRANTY*
<p>*Where xx = Fixture Light Engine lumen output designation. Example: 10 Year Warranty for LEM or LE20 Light engine is LEM/10YEARWARRANTY and LE20/10YEARWARRANTY respectively.</p>	



SPECFIT 8"

TECHNICAL INFORMATION

Light Engine	Input Voltage	Input Frequency	Input Current	Input Power	THD Power	Power Factor
LESXXX	120 / 277V	50 / 60Hz	0.115 / 0.047A	13W	<20%	>0.9
LEMXXX	120 / 277V	50 / 60Hz	0.270 / 0.114A	31.5W	<20%	>0.9
LELXXX	120 / 277V	50 / 60Hz	0.530 / 0.217A	60W	<20%	>0.9
LE05XXX	120 / 277V	50 / 60Hz	0.056 / 0.024A	6.5W	<20%	>0.9
LE07XXX	120 / 277V	50 / 60Hz	0.073 / 0.034A	8.5W	<20%	>0.9
LE10XXX	120 / 277V	50 / 60Hz	0.112 / 0.047A	13W	<20%	>0.9
LE15XXX	120 / 277V	50 / 60Hz	0.154 / 0.068A	18W	<20%	>0.9
LE20XXX	120 / 277V	50 / 60Hz	0.218 / 0.092A	25.5W	<20%	>0.9
LE25XXX	120 / 277V	50 / 60Hz	0.269 / 0.116A	31.5W	<20%	>0.9
LE30XXX	120 / 277V	50 / 60Hz	0.318 / 0.133A	37.5W	<20%	>0.9
LE40XXX	120 / 277V	50 / 60Hz	0.411 / 0.165A	48.5W	<20%	>0.9
LE50XXX	120 / 277V	50 / 60Hz	0.487 / 0.203A	57.5W	<20%	>0.9

NOMINAL PERFORMANCE

LES (LE05 / LE07 / LE10) - Low / Medium / High - 6.5 / 8.5 / 12.5W

CCT	2700K			3000K			3500K			4000K			5000K		
	Low	Medium	High	Low	Medium	High	Low	Medium	High	Low	Medium	High	Low	Medium	High
Output**	Im LPW	Im LPW	Im LPW	Im LPW	Im LPW	Im LPW	Im LPW	Im LPW	Im LPW	Im LPW	Im LPW	Im LPW	Im LPW	Im LPW	Im LPW
Finish	Im LPW	Im LPW	Im LPW	Im LPW	Im LPW	Im LPW	Im LPW	Im LPW	Im LPW	Im LPW	Im LPW	Im LPW	Im LPW	Im LPW	Im LPW
Clear Diffuse	500 77	700 82	1,000 80	525 81	735 86	1,050 84	550 85	770 91	1,100 88	575 88	805 95	1,150 92	580 89	810 95	1,165 93
White	495 76	693 82	990 79	520 80	728 86	1,040 83	545 84	762 90	1,089 87	569 88	797 94	1,139 91	574 88	802 94	1,153 92
Black	440 68	616 72	880 70	462 71	647 76	924 74	484 74	678 80	968 77	506 78	708 83	1012 81	510 78	714 84	1,015 81

LEM (LE15 / LE20 / LE25) - Low / Medium / High - 18.0 / 25.5 / 31.5W

CCT	2700K			3000K			3500K			4000K			5000K		
	Low	Medium	High	Low	Medium	High	Low	Medium	High	Low	Medium	High	Low	Medium	High
Output**	Im LPW	Im LPW	Im LPW	Im LPW	Im LPW	Im LPW	Im LPW	Im LPW	Im LPW	Im LPW	Im LPW	Im LPW	Im LPW	Im LPW	Im LPW
Finish	Im LPW	Im LPW	Im LPW	Im LPW	Im LPW	Im LPW	Im LPW	Im LPW	Im LPW	Im LPW	Im LPW	Im LPW	Im LPW	Im LPW	Im LPW
Clear Diffuse	1,600 89	2,125 83	2,500 79	1,632 91	2,169 85	2,550 81	1,664 92	2,210 87	2,600 83	1,696 94	2,253 88	2,650 84	1,713 95	2,275 89	2,677 85
White	1,584 88	2,104 82	2,475 78	1,616 90	2,147 84	2,525 80	1,647 91	2,188 86	2,574 82	1,679 93	2,230 87	2,624 83	1,696 94	2,252 88	2,650 84
Black	1,408 78	1,870 73	2,200 70	1,436 80	1,909 75	2,244 71	1,464 81	1,945 77	2,288 73	1,492 83	1,983 77	2,332 74	1,507 84	2,002 79	2,355 75

LEL (LE30 / LE40 / LE50) - Low / Medium / High - 37.5 / 48.5 / 60.0W

CCT	2700K			3000K			3500K			4000K			5000K		
	Low	Medium	High	Low	Medium	High	Low	Medium	High	Low	Medium	High	Low	Medium	High
Output**	Im LPW	Im LPW	Im LPW	Im LPW	Im LPW	Im LPW	Im LPW	Im LPW	Im LPW	Im LPW	Im LPW	Im LPW	Im LPW	Im LPW	Im LPW
Finish	Im LPW	Im LPW	Im LPW	Im LPW	Im LPW	Im LPW	Im LPW	Im LPW	Im LPW	Im LPW	Im LPW	Im LPW	Im LPW	Im LPW	Im LPW
Clear Diffuse	3,325 89	4,085 84	4,750 79	3,360 90	4,080 84	4,800 80	3,500 93	4,250 88	5,000 83	3,640 97	4,420 91	5,200 87	3,640 97	4,420 91	5,200 87
White	3,292 88	4,044 83	4,703 78	3,326 89	4,039 83	4,752 79	3,465 92	4,208 87	4,950 82	3,604 96	4,376 90	5,148 86	3,604 96	4,376 90	5,148 86
Black	2,826 78	3,472 71	4,038 67	2,856 77	3,468 71	4,080 68	2,975 79	3,613 75	4,250 71	3,094 82	3,757 77	4,420 74	2,829 75	3,757 77	4,420 74

** Lumen output are based on rated lumens, for exact value please refer to the IES files



SPECFIT 8"

PHOTOMETRY

LES9035-DIM010-UNV-VN-ADR8CC

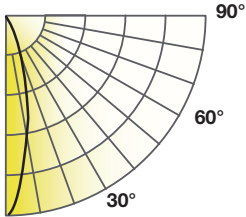

Lumens: 1,239 lm
 Power: 12.49 W
 Efficacy: 99.23 lm/W
 CRI: 90+
 Spacing Criteria: 0.42
 Beam Angle: 25.7°

Candlepower Distribution		Initial Footcandles			Zonal Lumen Summary		
Angle (°)	Average (cd)	Height (ft)	Fc	Diameter (ft)	Zone	Lumens	%Fixt
10	2,617	4	276	1.8	0-30	1,135	92%
20	1,156	6	123	2.7	0-40	1,223	99%
30	322	8	69	3.6	0-60	1,238	100%
40	32	10	44	4.5	0-90	1,239	100%
50	3	12	31	5.5			
60	1						
70	0						
80	0						
90	0						

LES9035-DIM010-UNV-NR-ADR8CC

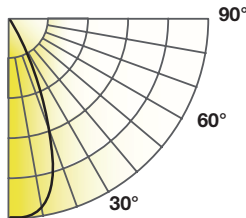

Lumens: 1,233 lm
 Power: 12.2 W
 Efficacy: 101 lm/W
 CRI: 90+
 Spacing Criteria: 0.6
 Beam Angle: 44°

Candlepower Distribution		Initial Footcandles			Zonal Lumen Summary		
Angle (°)	Average (cd)	Height (ft)	Fc	Diameter (ft)	Zone	Lumens	%Fixt
10	2,250	4	140	3.1	0-30	1,103	89%
20	1,464	6	62	4.7	0-40	1,220	99%
30	472	8	35	6.2	0-60	1,232	100%
40	45	10	22	7.8	0-90	1,233	100%
50	3	12	16	9.3			
60	1						
70	0						
80	0						
90	0						

LES9035-DIM010-UNV-MD-ADR8CC

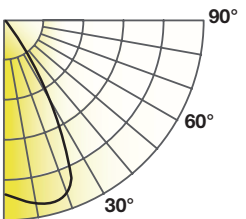

Lumens: 1,240 lm
 Power: 12.4 W
 Efficacy: 100 lm/W
 CRI: 90+
 Spacing Criteria: 0.9
 Beam Angle: 63°

Candlepower Distribution		Initial Footcandles			Zonal Lumen Summary		
Angle (°)	Average (cd)	Height (ft)	Fc	Diameter (ft)	Zone	Lumens	%Fixt
10	2,250	8	82	4.2	0-30	1,103	89%
20	1,464	10	36	6.3	0-40	1,220	99%
30	472	12	20	8.4	0-60	1,232	100%
40	45	15	13	10.4	0-90	1,240	100%
50	3	20	9	12.5			
60	1						
70	0						
80	0						
90	0						



SPECFIT 8"

PHOTOMETRY

LES9035-DIM010-UNV-WD-ADR8CC

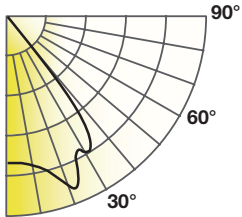

Lumens: 1,260 lm
Power: 12.3 W
Efficacy: 102 lm/W
CRI: 90+
Spacing Criteria: 1.2
Beam Angle: 63°

Candlepower Distribution		Initial Footcandles			Zonal Lumen Summary		
Angle (°)	Average (cd)	Height (ft)	Fc	Diameter (ft)	Zone	Lumens	%Fixt
10	759	4	59	6.0	0-30	681	54%
20	739	6	26	9.0	0-40	1,153	92%
30	936	8	15	12.1	0-60	1,257	100%
40	477	10	9	15.1	0-90	1,260	100%
50	10	12	7	18.1			
60	3						
70	1						
80	0						
90	0						

LEM9035-DIM010-UNV-VN-ADR8CC

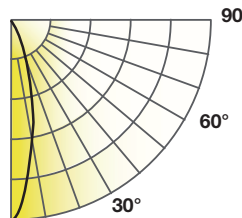

Lumens:2,566 lm
Power: 30.9 W
Efficacy: 83 lm/W
CRI: 90+
Spacing Criteria: 0.4
Beam Angle: 25°

Candlepower Distribution		Initial Footcandles			Zonal Lumen Summary		
Angle (°)	Average (cd)	Height (ft)	Fc	Diameter (ft)	Zone	Lumens	%Fixt
10	5,592	4	601	1.7	0-30	2357	92%
20	2178	6	267	2.6	0-40	2533	99%
30	635	8	150	3.4	0-60	2562	100%
40	88	10	96	4.3	0-90	2566	100%
50	12	12	67	5.2			
60	4						
70	1						
80	0						
90	0						

LEM9035-DIM010-UNV-NR-ADR8CC

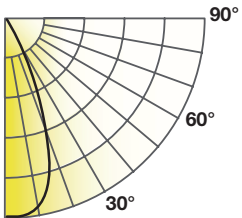

Lumens:2,582 lm
Power: 30.9 W
Efficacy: 83 lm/W
CRI: 90+
Spacing Criteria: 0.665
Beam Angle: 42°

Candlepower Distribution		Initial Footcandles			Zonal Lumen Summary		
Angle (°)	Average (cd)	Height (ft)	Fc	Diameter (ft)	Zone	Lumens	%Fixt
10	5,087	8	305	2.9	0-30	2,326	90%
20	2,558	10	136	4.3	0-40	2,554	99%
30	921	12	76	5.8	0-60	2,577	100%
40	86	15	49	7.2	0-90	2,582	100%
50	7	20	34	8.7			
60	2						
70	1						
80	0						
90	0						



SPECFIT 8"

PHOTOMETRY

LEM9035-DIM010-UNV-MD-ADR8CC

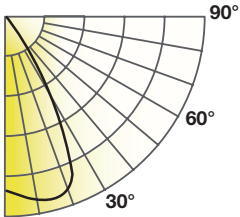

Lumens: 2548 lm
 Power: 31.3 W
 Efficacy: 81 lm/W
 CRI: 90+
 Spacing Criteria: 0.9
 Beam Angle: 63°

Candlepower Distribution		Initial Footcandles			Zonal Lumen Summary		
Angle (°)	Average (cd)	Height (ft)	Fc	Diameter (ft)	Zone	Lumens	%Fixt
10	2,648	4	167	3.7	0-30	2,024	79%
20	2,601	6	74	5.5	0-40	2,487	98%
30	1,307	8	42	7.3	0-60	2,543	100%
40	343	10	27	9.1	0-90	2,548	100%
50	10	12	19	11.0			
60	3						
70	1						
80	0						
90	0						

LEM9035-DIM010-UNV-WD-ADR8CC

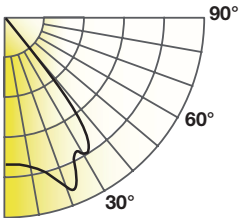

Lumens: 2567 lm
 Power: 31.3 W
 Efficacy: 82 lm/W
 CRI: 90+
 Spacing Criteria: 1.2
 Beam Angle: 82°

Candlepower Distribution		Initial Footcandles			Zonal Lumen Summary		
Angle (°)	Average (cd)	Height (ft)	Fc	Diameter (ft)	Zone	Lumens	%Fixt
10	1,524	4	118	6.4	0-30	1,308	51%
20	1,416	6	53	9.7	0-40	2,312	90%
30	2,054	8	30	13.0	0-60	2,558	100%
40	1,056	10	19	16.2	0-90	2,567	100%
50	29	12	13	19.4			
60	9						
70	4						
80	1						
90	0						

LEL9035-DIM010-UNV-VN-ADR8CC

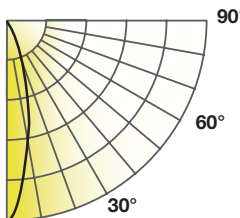

Lumens: 4767 lm
 Power: 60.8 W
 Efficacy: 78 lm/W
 CRI: 90+
 Spacing Criteria: 0.5
 Beam Angle: 32°

Candlepower Distribution		Initial Footcandles			Zonal Lumen Summary		
Angle (°)	Average (cd)	Height (ft)	Fc	Diameter (ft)	Zone	Lumens	%Fixt
10	793	4	175	4.6	0-30	4,068	85%
20	465	6	112	5.8	0-40	4,612	91%
30	238	8	78	6.9	0-60	5,038	99%
40	21	10	50	8.7	0-90	4,767	100%
50	3	12	28	11.5			
60	1						
70	0						
80	0						
90	0						



SPECFIT 8"

PHOTOMETRY

LEL9035-DIM010-UNV-NR-ADR8CC

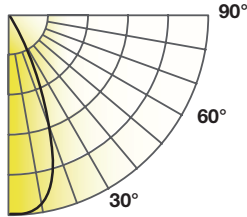

Lumens: 4885 lm
Power: 60.4 W
Efficacy: 81 lm/W
CRI: 90+
Spacing Criteria: 0.7
Beam Angle: 44°

Candlepower Distribution		Initial Footcandles			Zonal Lumen Summary		
Angle (°)	Average (cd)	Height (ft)	Fc	Diameter (ft)	Zone	Lumens	%Fixt
10	7,456	8	145	6.4	0-30	4,068	85%
20	5,085	10	93	8.0	0-40	4,666	98%
30	2,031	12	64	9.6	0-60	4,751	100%
40	202	15	41	12.0	0-90	4,885	100%
50	19	20	23	15.9			
60	7						
70	3						
80	1						
90	0						

LEL9035-DIM010-UNV-MD-ADR8CC

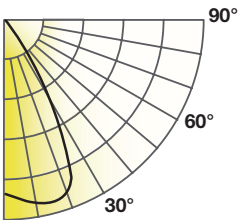

Lumens: 5041 lm
Power: 60.4 W
Efficacy: 83 lm/W
CRI: 90+
Spacing Criteria: 0.8
Beam Angle: 52°

Candlepower Distribution		Initial Footcandles			Zonal Lumen Summary		
Angle (°)	Average (cd)	Height (ft)	Fc	Diameter (ft)	Zone	Lumens	%Fixt
10	6,036	4	109	7.7	0-30	3,698	73%
20	4,389	6	70	9.6	0-40	4,897	97%
30	3,080	8	48	11.5	0-60	5,028	100%
40	891	10	31	14.4	0-90	5,041	100%
50	23	12	17	19.2			
60	8						
70	3						
80	1						
90	0						

LEL9035-DIM010-UNV-WD-ADR8CC

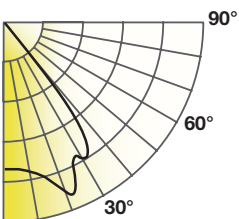

Lumens: 5064 lm
Power: 60.8 W
Efficacy: 83 lm/W
CRI: 90+
Spacing Criteria: 1.1
Beam Angle: 72°

Candlepower Distribution		Initial Footcandles			Zonal Lumen Summary		
Angle (°)	Average (cd)	Height (ft)	Fc	Diameter (ft)	Zone	Lumens	%Fixt
10	3,951	8	69	11.7	0-30	3,151	62%
20	3,789	10	44	14.6	0-40	4,680	92%
30	3,288	12	31	17.5	0-60	5,042	100%
40	1,604	15	20	21.9	0-90	5,064	100%
50	55	20	11	29.2			
60	18						
70	8						
80	3						
90	0						



SPECFIT 8"

PHOTOMETRY

LES9730-DIM010-UNV-MD-ADR8CC

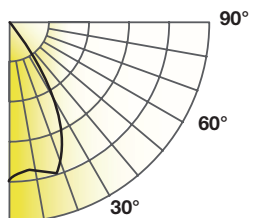

Lumens: 1,048 lm
Power: 13 W
Efficacy: 84 lm/W
CRI: 96
Spacing Criteria: 1.02
Beam Angle: 65°

Candlepower Distribution	
Angle (°)	Average (cd)
10	977
20	972
30	615
40	190
50	3
60	0
70	0
80	0
90	0

Initial Footcandles		
Height (ft)	Fc	Diameter (ft)
4	91	5.1
6	40	7.6
8	23	10.2
10	15	12.7
12	10	15.3

Zonal Lumen Summary		
Zone	Lumens	%Fixt
0-30	744	71%
0-40	1,001	96%
0-60	1,047	100%
0-90	1,048	100%

LEM9730-DIM010-UNV-MD-ADR8CC

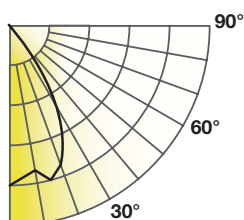

Lumens: 2,211 lm
Power: 33 W
Efficacy: 68 lm/W
CRI: 96
Spacing Criteria: 1.02
Beam Angle: 65°

Candlepower Distribution	
Angle (°)	Average (cd)
10	2,032
20	2,035
30	1,287
40	375
50	7
60	2
70	0
80	0
90	0

Initial Footcandles		
Height (ft)	Fc	Diameter (ft)
4	189	5.1
6	84	7.7
8	47	10.3
10	30	12.8
12	21	15.4

Zonal Lumen Summary		
Zone	Lumens	%Fixt
0-30	1,568	71%
0-40	2,113	96%
0-60	2,209	100%
0-90	2,211	100%

LEL9035-DIM010-UNV-WD-ADR8CC

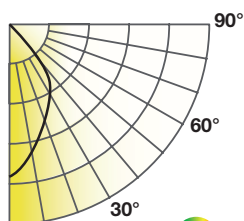

Lumens: 4,207 lm
Power: 60 W
Efficacy: 71 lm/W
CRI: 96
Spacing Criteria: 0.75
Beam Angle: 54°

Candlepower Distribution	
Angle (°)	Average (cd)
10	4,536
20	3,392
30	2,396
40	903
50	7
60	0
70	0
80	0
90	0

Initial Footcandles		
Height (ft)	Fc	Diameter (ft)
8	47	8.1
10	30	10.1
12	21	12.1
15	13	15.2
20	8	20.2

Zonal Lumen Summary		
Zone	Lumens	%Fixt
0-30	2,901	69%
0-40	4,005	95%
0-60	4,207	100%
0-90	4,207	100%



SPECFIT 8"

COLOR ACCURACY & SPECTRAL DISTRIBUTION FOR 97 CRI WITH TRUE CHROMA

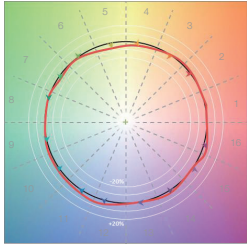
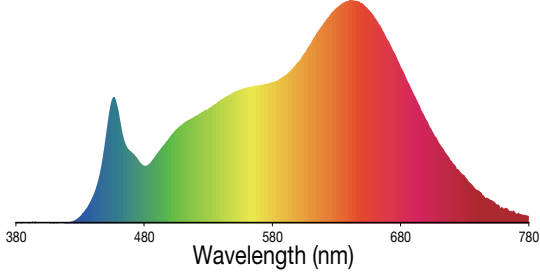
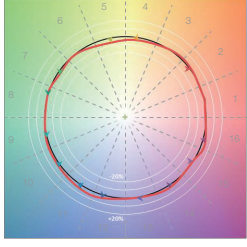
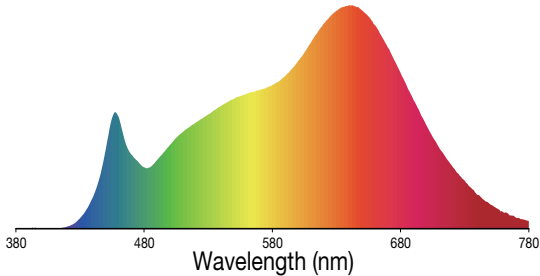
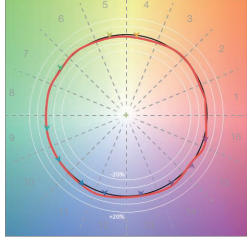
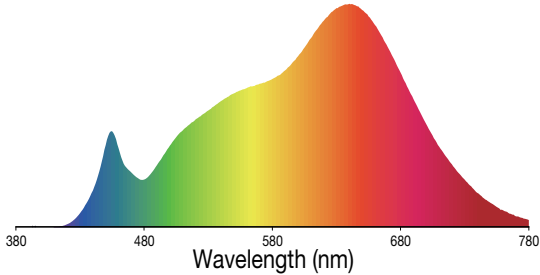

CCT	COLOR ACCURACY	SPECTRAL POWER DISTRIBUTION
LES9730DIM010UNVMD	 <p>Rr: 93, Rg: 101</p>	 <p>Wavelength (nm)</p>
LEM9730DIM010UNVMD	 <p>Rr: 94, Rg: 101</p>	 <p>Wavelength (nm)</p>
LEL9730DIM010UNVMD	 <p>Rr: 95, Rg: 101</p>	 <p>Wavelength (nm)</p>

Rf: TM-30 metric measuring color fidelity (whether colors are similar to those under natural light). Rf is a more accurate version of the CRI Ra. Rf is 100 for natural light.

Rg: TM-30 metric measuring color gamut (whether colors are more saturated than under natural light). Rg is 100 for natural light.