

Project Name:	Type:
Part Number:	Date:

# SPECFIT 4"

## SPECIFICATION FEATURES

- **Mechanical** - SPECFIT retrofits existing commercial housings. Spring action clips to accommodate ½" to 2" ceiling thicknesses. Fixture with remote driver installs and is accessible from below the ceiling.
- **Electrical** - Standard driver option is 120-277V, 50/60 Hz with three selectable lumen outputs using SelectDrive technology. 0-10V dimmable to 5% with low end cutoff. 12V auxiliary port with stand by power functionality for additional dimming and control of field installed sensors and control systems. Additional driver selections include a 120V line voltage forward and reverse phase dimming option down to 5%, Lutron Ecosystem 5% and 1% dimming driver options and a Philips EasySense sensor compatible driver option.
- **Optical** - Self flanged spun aluminum reflector. 45° optical cutoff. Field interchangeable optical lenses. Four beam distributions. Wall wash field installed accessory. COB LED binned to 3-step SDCM to ensure color uniformity in 2700K, 3000K, 3500K, 4000K or 5000K CCT. Minimum 90 CRI. 97 CRI available in 3000K only.
- **Thermal** - Die cast heat sink. L70 lifetime of 100,000 hours. Fixture operating temperature: -13°F to +95°F (-25°C to 35°C).
- **Compliance and Warranty** - ETL Classified and Listed for damp locations. 5 year parts warranty for complete fixture. Optional 10 Year Extended Warranty available, subject to same terms, conditions and installation requirements as standard 5 Year Warranty.



## BENEFITS

- Get the right amount of light with SelectDrive technology
- Match ceiling décor with field interchangeable trims
- Direct the light with field interchangeable optics
- Various dimming driver options allow for control and energy savings
- Long 100,000 hours L70 rated lifetime

## APPLICATIONS

- Commercial Office
- Hospitality
- Retail
- Educational
- Healthcare

## DIMENSIONS

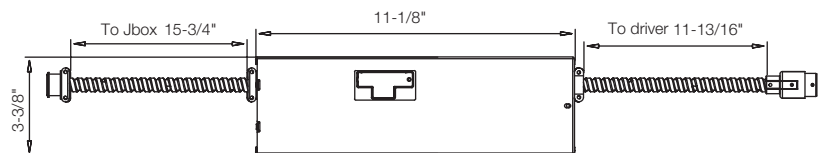
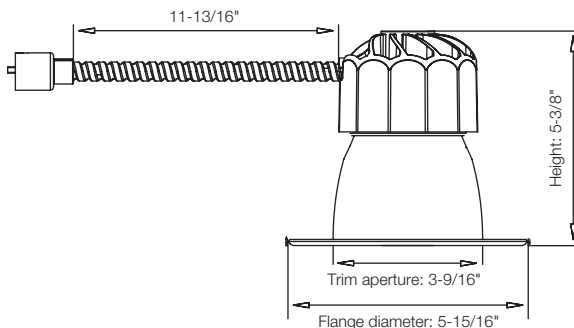

Minimum Ceiling Opening: 3-3/4" Maximum Ceiling Opening: 5-3/16"

032521



# SPECFIT 4"

## ORDERING EXAMPLE

A complete fixture consists of one light engine and one reflector.

SelectDrive Light Engine: LEM9040DIM010UNVMD  
Reflector: ADR4CC

## ORDERING INFORMATION

### SelectDrive Light Engines

Light Engine	CRI	CCT	Driver	Optical Distribution	Options <sup>7</sup>
<input type="checkbox"/> <b>LES</b> Small Light Engine 500-700-1,000 lumens	<input type="checkbox"/> <b>90</b> 90+CRI	<input type="checkbox"/> <b>27</b> 2700K	<input type="checkbox"/> <b>DIM010UNV<sup>2</sup></b> SelectDrive 120-277V, 50/60Hz 0-10V Dimmable to 5%	<input type="checkbox"/> <b>MD<sup>1</sup></b> Medium (Installed Standard) 60° Beam angle	<input type="checkbox"/> <b>SD347</b> 347V - 240V Step Down Transformer
<input type="checkbox"/> <b>LEM</b> Medium Light Engine 1,500-2,000-2,500 lumens	<input type="checkbox"/> <b>97<sup>3</sup></b> 97 CRI 3000K only	<input type="checkbox"/> <b>30</b> 3000K		<input type="checkbox"/> <b>VN</b> Very Narrow 25° Beam angle	<input type="checkbox"/> <b>SD480</b> 480V - 240V Step Down Transformer
		<input type="checkbox"/> <b>35</b> 3500K		<input type="checkbox"/> <b>NR</b> Narrow 40° Beam angle	<input type="checkbox"/> <b>EM<sup>4</sup></b> 10.7W Emergency Backup
		<input type="checkbox"/> <b>40</b> 4000K		<input type="checkbox"/> <b>WD</b> Wide 75° Beam angle	<input type="checkbox"/> <b>EM<sup>4</sup> -CEC</b> California Title 20 Compliant 10.7W Emergency Backup
		<input type="checkbox"/> <b>50</b> 5000K			<input type="checkbox"/> <b>OUT</b> Outdoor Debris Ingress Protection

### Reflectors

Shape	Finish
<input type="checkbox"/> <b>ADR4</b> 4" Round Reflector	<input type="checkbox"/> <b>CC</b> Clear Diffuse Trim and Flange <input type="checkbox"/> <b>WH</b> Matte White Trim and Flange
	<input type="checkbox"/> <b>CW</b> Clear Diffuse Trim, White Flange <input type="checkbox"/> <b>BL</b> Matte Black Trim and Flange

<sup>1</sup> Medium Lens Optic comes installed as standard, if other optic distribution selected the lens will ship separately and require field installation. / <sup>2</sup> Dims to 5% with low end cutoff. Dimmer compatibility available on website. / <sup>3</sup> CRI97 TRUE CHROMA is only available in 3000K only and is not Energy Star rated. / <sup>4</sup> EM cannot be combined with SD347 or SD480 option. / <sup>7</sup> Options are factory installed and come with the Light Engine and Driver.



# SPECFIT 4"

## ORDERING EXAMPLE

A complete fixture consists of one light engine and one reflector.

Philips Light Engine W/ Enlighted Micro Sensor: Reflector:	LE259040PSRUNVWNENLS-IOT ADR4CC	Philips Light Engine W/ EasySense Sensor: Reflector:	LE059030PSRUNVNES ADR4CW
120V Light Engine: Reflector:	LE209035DIM120VWD ADR4BL	Lutron EcoSystem Light Engine: Reflector:	LE159027LUT5UNVNR ADR4WH

## ORDERING INFORMATION

### Fixed Output Light Engines

Light Engine	CRI	CCT	Driver	Optical Distribution	Options <sup>7</sup>
<input type="checkbox"/> <b>LE05<sup>8</sup></b> 500 lumens	<input type="checkbox"/> <b>90</b> 90+CRI	<input type="checkbox"/> <b>27</b> 2700K	<input type="checkbox"/> <b>DIM120V</b> 120V Dimmable, 120V	<input type="checkbox"/> <b>MD<sup>1</sup></b> Medium (Installed Standard) 60° Beam angle	<input type="checkbox"/> <b>SD347</b> 347V - 240V Step Down Transformer
<input type="checkbox"/> <b>LE07</b> 700 lumens	<input type="checkbox"/> <b>97<sup>3</sup></b> 97 CRI 3000K only	<input type="checkbox"/> <b>30</b> 3000K	<input type="checkbox"/> <b>PSRUNV</b> 0-10V Driver + SR Ready Bridge, 120-277V	<input type="checkbox"/> <b>VN</b> Very Narrow 25° Beam angle	<input type="checkbox"/> <b>SD480</b> 480V - 240V Step Down Transformer
<input type="checkbox"/> <b>LE10</b> 1,000 lumens		<input type="checkbox"/> <b>35</b> 3500K	<input type="checkbox"/> <b>XT010UNV</b> Signify 0-10V Driver 1% Dimming, 120-277V	<input type="checkbox"/> <b>NR</b> Narrow 40° Beam angle	<input type="checkbox"/> <b>EM<sup>4</sup></b> 10.7W Emergency Backup
<input type="checkbox"/> <b>LE15</b> 1,500 lumens		<input type="checkbox"/> <b>40</b> 4000K	<input type="checkbox"/> <b>LUT-1UNV</b> Lutron EcoSystem 1% Dimming, 120-277V	<input type="checkbox"/> <b>WD</b> Wide 75° Beam angle	<input type="checkbox"/> <b>EM<sup>4</sup>-CEC</b> California Title 20 Compliant 10.7W Emergency Backup
<input type="checkbox"/> <b>LE20</b> 2,000 lumens		<input type="checkbox"/> <b>50</b> 5000K	<input type="checkbox"/> <b>LUT-5UNV</b> Lutron EcoSystem 5% Dimming, 120-277V		<input type="checkbox"/> <b>ES<sup>5</sup></b> Philips EasySense ceiling mount sensor
<input type="checkbox"/> <b>LE25</b> 2,500 lumens			<input type="checkbox"/> <b>LUT-L3DUNV</b> Lutron Hi-lume 3-Wire 1% Dimming, 120-277V		<input type="checkbox"/> <b>ENLS<sup>6</sup>-IL</b> Enlighted Two Wire <b>ENLIGHTED ONE</b> Compact Sensor
			<input type="checkbox"/> <b>ELD-E010UNV</b> EldoLED ECOdrive 0-10V 1%, 120-277V		<input type="checkbox"/> <b>ENLS<sup>6</sup>-CL</b> Enlighted Two Wire <b>CONNECTED LIGHTING</b> Compact Sensor
			<input type="checkbox"/> <b>ELD-EDALIUNV</b> EldoLED ECOdrive DALI 1%, 120-277V		<input type="checkbox"/> <b>ENLS<sup>6</sup>-IOT</b> Enlighted Two Wire <b>IOT</b> Compact Sensor
			<input type="checkbox"/> <b>ELD-S010UNV</b> EldoLED SOLOdrive 0-10V 0.1%, 120-277V		<input type="checkbox"/> <b>OUT</b> Outdoor Debris Ingress Protection
			<input type="checkbox"/> <b>ELD-SDALIUNV</b> EldoLED SOLOdrive DALI 0.1%, 120-277V		

### Reflectors





Shape	Finish
<input type="checkbox"/> <b>ADR4</b> 4" Round Reflector	<input type="checkbox"/> <b>CC</b> Clear Diffuse Trim and Flange <input type="checkbox"/> <b>WH</b> Matte White Trim and Flange
	<input type="checkbox"/> <b>CW</b> Clear Diffuse Trim, White Flange <input type="checkbox"/> <b>BL</b> Matte Black Trim and Flange

<sup>1</sup> Medium Lens Optic comes installed as standard, if other optic distribution selected the lens will ship separately and require field installation. / <sup>3</sup> CRI97 TRUE CHROMA is only available in 3000K only and is not Energy Star rated. / <sup>4</sup> EM cannot be combined with SD347 or SD480 option. / <sup>5</sup> Philips EasySense ceiling mounted sensor is only available with the PSRUNV driver. / <sup>6</sup> Enlighted Two Wire Compact Sensor with ceiling mount is only available with the PSRUNV driver. / <sup>7</sup> Options are factory installed and come with the Light Engine and Driver. / <sup>8</sup> LE05 is not available with LUT-5UNV.

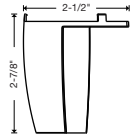

# SPECFIT 4"

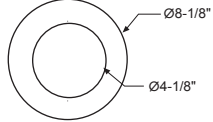
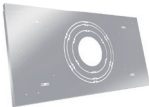
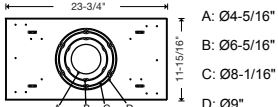
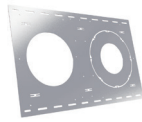
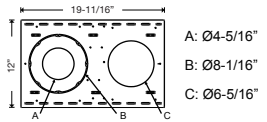
## ACCESSORY ORDERING INFORMATION

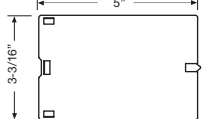
Product	Model	Description	Pictures	Dimensions
98079	ADWAW	Wall Wash (Field Installed on Module)		
98569	GOOFRING4	4" Goof Ring - Outer Diameter 8-1/8"		
98501	NCPLATE/T4689	New Construction Plate for T-Grid ceilings		 A: Ø4-5/16" B: Ø6-5/16" C: Ø8-1/16" D: Ø9"
98502	NCPLATE468	New Construction Plate for Stud/Joist ceilings		 A: Ø4-5/16" B: Ø8-1/16" C: Ø6-5/16"
98583	NCPLATEJB	Junction box for New Construction Plates		

## 10 YEAR EXTENDED WARRANTY

Model	LExx/10YEARWARRANTY*
*Where xx = Fixture Light Engine lumen output designation. Example: 10 Year Warranty for LEM or LE20 Light engine is LEM/10YEARWARRANTY and LE20/10YEARWARRANTY respectively.	



# SPECFIT 4"

## TECHNICAL INFORMATION

Light Engine	Input Voltage	Input Frequency	Input Current	Input Power	THD Power	Power Factor
LESXXXX	120 / 277V	50 / 60Hz	0.115 / 0.047A	13W	<20%	>0.9
LEMXXXX	120 / 277V	50 / 60Hz	0.270 / 0.114A	31.5W	<20%	>0.9
LE05XXXX	120 / 277V	50 / 60Hz	0.056 / 0.024A	6.5W	<20%	>0.9
LE07XXXX	120 / 277V	50 / 60Hz	0.073 / 0.034A	8.5W	<20%	>0.9
LE10XXXX	120 / 277V	50 / 60Hz	0.112 / 0.047A	13W	<20%	>0.9
LE15XXXX	120 / 277V	50 / 60Hz	0.154 / 0.068A	18W	<20%	>0.9
LE20XXXX	120 / 277V	50 / 60Hz	0.218 / 0.092A	25.5W	<20%	>0.9
LE25XXXX	120 / 277V	50 / 60Hz	0.269 / 0.116A	31.5W	<20%	>0.9

## NOMINAL PERFORMANCE

### LES (LE05 / LE07 / LE10) - Low / Medium / High - 6.5 / 8.5 / 12.5W

CCT	2700K			3000K			3500K			4000K			5000K		
	Low	Medium	High	Low	Medium	High	Low	Medium	High	Low	Medium	High	Low	Medium	High
Output**	Im LPW	Im LPW	Im LPW	Im LPW	Im LPW	Im LPW	Im LPW	Im LPW	Im LPW	Im LPW	Im LPW	Im LPW	Im LPW	Im LPW	Im LPW
Finish	Im LPW	Im LPW	Im LPW	Im LPW	Im LPW	Im LPW	Im LPW	Im LPW	Im LPW	Im LPW	Im LPW	Im LPW	Im LPW	Im LPW	Im LPW
Clear Diffuse	500 77	700 82	1,000 80	525 81	735 86	1,050 84	550 85	770 91	1,100 88	575 88	805 95	1,150 92	580 89	810 95	1,165 93
White	495 76	693 82	990 79	520 80	728 86	1,040 83	545 84	762 90	1,089 87	569 88	797 94	1,139 91	574 88	802 94	1,153 92
Black	440 68	616 72	880 70	462 71	647 76	924 74	484 74	678 80	968 77	506 78	708 83	1,012 81	510 78	714 84	1,015 81

\*\* Lumen output are based on rated lumens, for exact value please refer to the IES files

### LEM (LE15 / LE20 / LE25) - Low / Medium / High - 18.0 / 25.5 / 31.5W

CCT	2700K			3000K			3500K			4000K			5000K		
	Low	Medium	High	Low	Medium	High	Low	Medium	High	Low	Medium	High	Low	Medium	High
Output**	Im LPW	Im LPW	Im LPW	Im LPW	Im LPW	Im LPW	Im LPW	Im LPW	Im LPW	Im LPW	Im LPW	Im LPW	Im LPW	Im LPW	Im LPW
Finish	Im LPW	Im LPW	Im LPW	Im LPW	Im LPW	Im LPW	Im LPW	Im LPW	Im LPW	Im LPW	Im LPW	Im LPW	Im LPW	Im LPW	Im LPW
Clear Diffuse	1,600 89	2,125 83	2,500 79	1,632 91	2,169 85	2,550 81	1,664 92	2,210 87	2,600 83	1,696 94	2,253 88	2,650 84	1,713 95	2,275 89	2,677 85
White	1,584 88	2,104 82	2,475 78	1,616 90	2,147 84	2,525 80	1,647 91	2,188 86	2,574 82	1,679 93	2,230 87	2,624 83	1,696 94	2,252 88	2,650 84
Black	1,408 78	1,870 73	2,200 70	1,436 80	1,909 75	2,244 71	1,464 81	1,945 77	2,288 73	1,492 83	1,983 77	2,332 74	1,507 84	2,002 79	2,355 75

\*\* Lumen output are based on rated lumens, for exact value please refer to the IES files



# SPECFIT 4"

## PHOTOMETRY

LES9035-DIM010-UNV-VN-ADR4CC

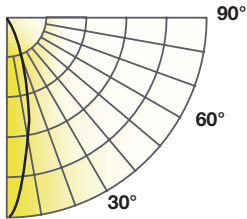

Lumens: 1,191 lm  
Power: 13 W  
Efficacy: 95 lm/W  
CRI: 90+  
Spacing Criteria: 0.44  
Beam Angle: 27°

Candlepower Distribution		Initial Footcandles			Zonal Lumen Summary		
Angle (°)	Average (cd)	Height (ft)	Fc	Diameter (ft)	Zone	Lumens	%Fixt
10	2,609	4	269	1.9	0-30	1,051	88%
20	1,031	6	120	2.9	0-40	1,128	95%
30	179	8	67	3.8	0-60	1,185	100%
40	90	10	43	4.8	0-90	1,191	100%
50	27	12	30	5.7			
60	6						
70	2						
80	0						
90	0						

LES9035-DIM010-UNV-NR-ADR4CC

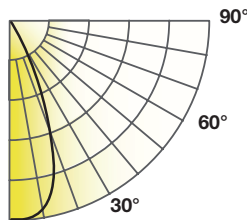

Lumens: 1,215 lm  
Power: 12.3 W  
Efficacy: 98 lm/W  
CRI: 90+  
Spacing Criteria: 0.67  
Beam Angle: 46°

Candlepower Distribution		Initial Footcandles			Zonal Lumen Summary		
Angle (°)	Average (cd)	Height (ft)	Fc	Diameter (ft)	Zone	Lumens	%Fixt
10	2,153	4	129	3.0	0-30	1,068	88%
20	1,477	6	57	4.5	0-40	1,167	96%
30	339	8	32	6.0	0-60	1,210	100%
40	72	10	21	7.6	0-90	1,215	100%
50	20	12	14	9.1			
60	5						
70	1						
80	0						
90	0						

LES9035-DIM010-UNV-MD-ADR4CC

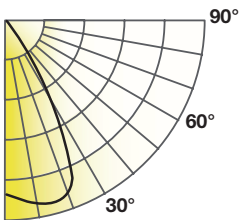

Lumens: 1,226 lm  
Power: 12.3 W  
Efficacy: 99 lm/W  
CRI: 90+  
Spacing Criteria: 1.0  
Beam Angle: 69°

Candlepower Distribution		Initial Footcandles			Zonal Lumen Summary		
Angle (°)	Average (cd)	Height (ft)	Fc	Diameter (ft)	Zone	Lumens	%Fixt
10	1,153	4	74	4.2	0-30	906	74%
20	1,238	6	33	6.4	0-40	1,160	95%
30	704	8	18	8.5	0-60	1,221	100%
40	137	10	12	10.6	0-90	1,226	100%
50	26	12	8	12.8			
60	6						
70	2						
80	0						
90	0						

# SPECFIT 4"

## PHOTOMETRY

LES9035-DIM010-UNV-WD-ADR4CC

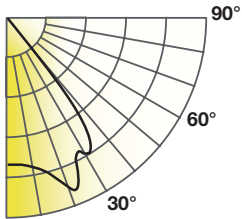

Lumens: 1,218 lm  
 Power: 12.5 W  
 Efficacy: 98 lm/W  
 CRI: 90+  
 Spacing Criteria: 1.2  
 Beam Angle: 82°

Candlepower Distribution		Initial Footcandles			Zonal Lumen Summary		
Angle (°)	Average (cd)	Height (ft)	Fc	Diameter (ft)	Zone	Lumens	%Fixt
10	654	4	43	6.4	0-30	628	52%
20	771	6	19	9.7	0-40	1,068	88%
30	746	8	11	12.9	0-60	1,206	99%
40	438	10	7	16.1	0-90	1,218	100%
50	54	12	5	19.4			
60	13						
70	4						
80	1						
90	0						

LEM9035-DIM010-UNV-VN-ADR4CC

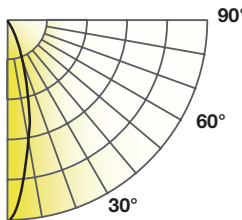

Lumens: 2,468 lm  
 Power: 31.0 W  
 Efficacy: 80 lm/W  
 CRI: 90+  
 Spacing Criteria: 0.42  
 Beam Angle: 25°

Candlepower Distribution		Initial Footcandles			Zonal Lumen Summary		
Angle (°)	Average (cd)	Height (ft)	Fc	Diameter (ft)	Zone	Lumens	%Fixt
10	5,647	4	585	1.8	0-30	2,181	88%
20	2,065	6	217	2.9	0-40	2,337	95%
30	381	8	97	4.3	0-60	2,454	98%
40	201	10	54	5.8	0-90	2,468	100%
50	60	12	35	7.2			
60	14						
70	4						
80	1						
90	0						

LEM9035-DIM010-UNV-NR-ADR4CC

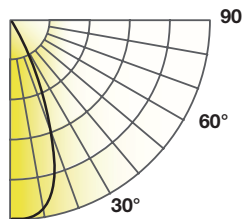

Lumens: 2,508 lm  
 Power: 31.0 W  
 Efficacy: 81 lm/W  
 CRI: 90+  
 Spacing Criteria: 0.72  
 Beam Angle: 49°

Candlepower Distribution		Initial Footcandles			Zonal Lumen Summary		
Angle (°)	Average (cd)	Height (ft)	Fc	Diameter (ft)	Zone	Lumens	%Fixt
10	4,582	4	276	2.6	0-30	2,231	89%
20	2,831	6	121	3.9	0-40	2,412	96%
30	650	8	68	5.2	0-60	2,498	100%
40	151	10	44	6.5	0-90	2,508	100%
50	45	12	30	7.9			
60	10						
70	3						
80	1						
90	0						



# SPECFIT 4"

## PHOTOMETRY

LEM9035-DIM010-UNV-MD-ADR4CC

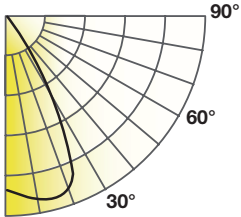

Lumens: 2517 lm  
Power: 30.95 W  
Efficacy: 81.17 lm/W  
CRI: 90+  
Spacing Criteria: 1.0  
Beam Angle: 71°

Candlepower Distribution		Initial Footcandles			Zonal Lumen Summary		
Angle (°)	Average (cd)	Height (ft)	Fc	Diameter (ft)	Zone	Lumens	%Fixt
10	2203	4	161	4.2	0-30	1852	74%
20	2885	6	72	6.4	0-40	2389	95%
30	1436	8	40	8.5	0-60	2506	100%
40	275	10	26	10.6	0-90	2517	100%
50	47	12	18	12.8			
60	11						
70	3						
80	1						
90	0						

LEM9035-DIM010-UNV-WD-ADR4CC

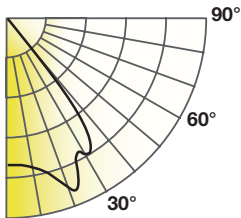

Lumens: 2471 lm  
Power: 31.5 W  
Efficacy: 78 lm/W  
CRI: 90+  
Spacing Criteria: 1.225  
Beam Angle: 83°

Candlepower Distribution		Initial Footcandles			Zonal Lumen Summary		
Angle (°)	Average (cd)	Height (ft)	Fc	Diameter (ft)	Zone	Lumens	%Fixt
10	1317	4	81	6.4	0-30	1216	49%
20	1494	6	30	9.7	0-40	2157	29%
30	1591	8	13	12.9	0-60	2445	99%
40	1040	10	8	16.1	0-90	2471	100%
50	134	12	5	19.4			
60	34						
70	11						
80	3						
90	0						





# SPECFIT 4"

## PHOTOMETRY

LES9730-DIM010-UNV-MD-ADR4CC

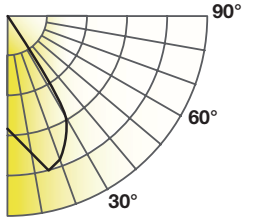

Lumens: 1032 lm  
CBCP: 1067 cd  
Power: 13 W  
Efficacy: 83 lm/W  
CRI: 96  
Spacing Criteria: 1.14  
Beam Angle: 63.5°

Candlepower Distribution	
Angle (°)	Average (cd)
10	870
20	987
30	594
40	185
50	18
60	1
70	1
80	0
90	0

Initial Footcandles		
Height (ft)	Fc	Diameter (ft)
4	81	5.0
6	36	7.4
8	20	9.9
10	13	12.4
12	9	14.9

Zonal Lumen Summary		
Zone	Lumens	%Fixt
0-30	724	70%
0-40	971	94%
0-60	1030	100%
0-90	1032	100%

LEM9730-DIM010-UNV-MD-ADR4CC

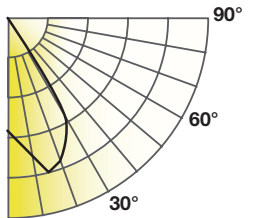

Lumens: 2165 lm  
CBCP: 2236 cd  
Power: 33 W  
Efficacy: 66 lm/W  
CRI: 96  
Spacing Criteria: 1.14  
Beam Angle: 64°

Candlepower Distribution	
Angle (°)	Average (cd)
10	1,822
20	2,061
30	1,242
40	399
50	38
60	8
70	3
80	1
90	0

Initial Footcandles		
Height (ft)	Fc	Diameter (ft)
4	169	5.0
6	75	7.4
8	42	9.9
10	27	12.4
12	19	14.9

Zonal Lumen Summary		
Zone	Lumens	%Fixt
0-30	1518	70%
0-40	2036	94%
0-60	2159	100%
0-90	2165	100%



# SPECFIT 4"

## COLOR ACCURACY & SPECTRAL DISTRIBUTION FOR 97 CRI WITH TRUE CHROMA

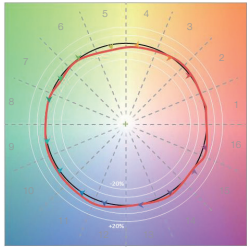
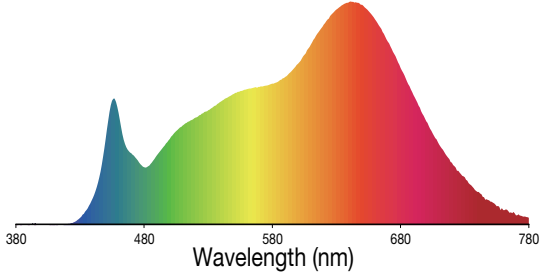
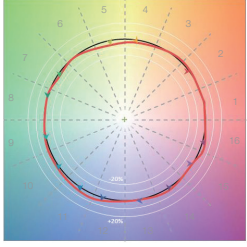
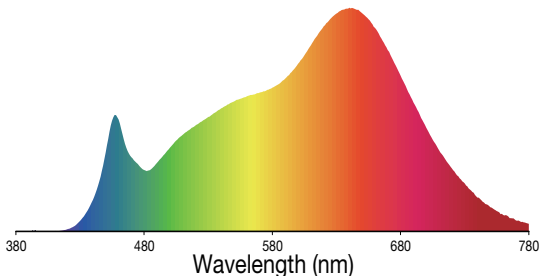

CCT	COLOR ACCURACY	SPECTRAL POWER DISTRIBUTION
LES9730DIM010UNVMD	 <p>Rr: 93, Rg: 101</p>	 <p>Wavelength (nm)</p>
LEM9730DIM010UNVMD	 <p>Rr: 94, Rg: 101</p>	 <p>Wavelength (nm)</p>

Rf: TM-30 metric measuring color fidelity (whether colors are similar to those under natural light). Rf is a more accurate version of the CRI Ra. Rf is 100 for natural light.  
 Rg: TM-30 metric measuring color gamut (whether colors are more saturated than under natural light). Rg is 100 for natural light.