

Project Name:	Type:
Part Number:	Date:

PXCYL CYLINDER 6"

SPECIFICATION FEATURES

- **Mechanical** - Compact fixture body made from die cast aluminum. Proprietary selectable output driver and polycarbonate lens design provide high quality light to compliment any space. Fixture bodies are available in matte black and matte white, or additional customized colors. Available in Surface, Pendant, Swivel, Suspension cable or Wall mount configuration.
- **Electrical** - Two selectable lumen output driver options with SelectDrive technology. The 120V, 50/60 Hz driver is forward or reverse phase dimmable to 5%. The 120-277V, 50/60 Hz driver is 0-10V dimmable to 5% with a low end cutoff and comes with a 12V auxiliary port that provides power for field installed sensors and control modules. Static lumen output driver options include the Lutron 5-Series Ecosystem driver which provides smooth dimming to 5% and the Lutron Hi-Lume 1% EcoSystem driver with Soft-On, Fade-to-Black which dims to 1%. EldoLED ECOdrive and SOLOdrive drivers are available in 0-10V and DALI configurations and dim smoothly to 1% and 0.1% respectively. Enlighted compact sensors and Philips EasySense sensors are field installable and directly integrate with the factory provided Philips Xitanium driver and Sensor Ready bridge.
- **Optical** - Flanged spun aluminum reflector. 45° optical cutoff. Field interchangeable optical lenses. Five beam distributions ranging from 15°-75°. Wall wash field installed accessory. COB LED binned to 3-step SDCM to ensure color uniformity in 2700K, 3000K, 3500K, 4000K or 5000K CCT. Minimum 90 CRI. 97 CRI with TRUE CHROMA available in 3000K only.
- **Thermal** - Die cast heat sink maximizes passive thermal management and achieves an L70 rated lifetime of 50,000 hours. Fixture operating temperature: -22°F to 95°F (-30°C to 35°C). With EM-INT option fixture should be installed in a controlled environment with ambient temperature not exceeding 77°F (25°C).
- **Compliance and Warranty** - ETL Listed for damp location, WET location available for Surface Mount and Wall Mount downlighting under covered ceiling. Complies with FCC 47CFR Part 15B consumer limits for EMI/RFI emissions. 5 year parts warranty for complete fixture. Optional 10 Year Extended Warranty available, subject to same terms, conditions and installation requirements as standard 5 Year Warranty.



092321



BENEFITS

- Get the right amount of light with SelectDrive technology
- Multiple finish and customization available to match any décor
- Surface, Pendant, Cable, Down-wall and Up-wall mounting options are available.
- Field interchangeable optics ensure smooth light levels
- Large variety of dimming and sensor control options

APPLICATIONS

- Retail
- Hospitality
- Residential
- Education
- Healthcare



PXCYL CYLINDER 6"

ORDERING INFORMATION

ORDERING EXAMPLE: PXCYL6/SM/LEM9035/KDIM010UNV/MD/WH/CC

SelectDrive Light Engine

PXCYL	6	/	/	/	/	/	/	/	/	/
Model Series	Size	Mounting	Light Engine	CRI	CCT	Driver	Optical Distribution	Cylinder Finish	Reflector Finish	Options
<input type="checkbox"/> PXCYL PXCYL Cylinder	<input type="checkbox"/> 6 6"	<input type="checkbox"/> SM Surface Mount	<input type="checkbox"/> LES Small Light Engine 500-700-1000 lumens	<input type="checkbox"/> 90 CRI 90+	<input type="checkbox"/> 27 ³ 2700K	<input type="checkbox"/> KDIM120V SelectDrive 120V, 50/60Hz Forward/Reverse phase dimming	<input type="checkbox"/> SP ¹¹ Spot 15° Beam Angle	<input type="checkbox"/> WH Matte White	<input type="checkbox"/> CC Clear	<input type="checkbox"/> EM ⁵ 10W Field Installable Emergency Backup
		<input type="checkbox"/> CM ¹ Cable Mount Ready	<input type="checkbox"/> LEM Medium Light Engine 1500-2000-2500 lumens	<input type="checkbox"/> 97 ² 97 CRI 3000K TRUE CHROMA	<input type="checkbox"/> 30 3000K	<input type="checkbox"/> KDIM010UNV SelectDrive 120-277V, 50/60Hz 0-10V dimming	<input type="checkbox"/> VN Very Narrow 25° Beam Angle	<input type="checkbox"/> BL Matte Black	<input type="checkbox"/> WH White	<input type="checkbox"/> EM ⁵ -CEC 10W Field Installable Emergency Backup California Compliant
		<input type="checkbox"/> PM ¹ Pendant Mount Ready	<input type="checkbox"/> LEL Large Light Engine 3000-4000-5000 lumens		<input type="checkbox"/> 35 3500K		<input type="checkbox"/> NR Narrow 40° Beam Angle	<input type="checkbox"/> CZ ⁴ Customized	<input type="checkbox"/> CZ ⁴ Customized	<input type="checkbox"/> EM-INT ¹² 6W Integrated EM Backup CEC Compliant
		<input type="checkbox"/> WM Wall Mount			<input type="checkbox"/> 40 4000K		<input type="checkbox"/> MD Medium 60° Beam Angle			<input type="checkbox"/> WET ¹⁰ Wet Location Ready
		<input type="checkbox"/> WMUP Wall Mount Up lighting			<input type="checkbox"/> 50 ³ 5000K		<input type="checkbox"/> WD Wide 75° Beam Angle			

Fixed Lumen Output Light Engine

PXCYL	6	/	/	/	/	/	/	/	/	/
Model Series	Size	Mounting	Light Engine	CRI	CCT	Driver	Optical Distribution	Cylinder Finish	Reflector Finish	Options
<input type="checkbox"/> PXCYL PXCYL Cylinder	<input type="checkbox"/> 6 6"	<input type="checkbox"/> SM Surface Mount	<input type="checkbox"/> LE05 ⁵ 500 lumens	<input type="checkbox"/> 90 CRI 90+	<input type="checkbox"/> 27 ³ 2700K	<input type="checkbox"/> PSRUNV 0-10V Xitanium Driver + SR Ready Bridge, 120-277V	<input type="checkbox"/> SP ¹¹ Spot 15° Beam Angle	<input type="checkbox"/> WH Matte White	<input type="checkbox"/> CC Clear	<input type="checkbox"/> EM ⁵ 10W Field Installable Emergency Backup
		<input type="checkbox"/> CM ¹ Cable Mount Ready	<input type="checkbox"/> LE07 700 lumens	<input type="checkbox"/> 97 ² 97 CRI 3000K TRUE CHROMA	<input type="checkbox"/> 30 3000K	<input type="checkbox"/> XT010UNV 0-10V 1% Xitanium Driver, 120-277V	<input type="checkbox"/> VN Very Narrow 25° Beam Angle	<input type="checkbox"/> BL Matte Black	<input type="checkbox"/> WH White	<input type="checkbox"/> EM ⁵ -CEC 10W Field Installable Emergency Backup California Compliant
		<input type="checkbox"/> PM ¹ Pendant Mount Ready	<input type="checkbox"/> LE10 1,000 lumens		<input type="checkbox"/> 35 3500K	<input type="checkbox"/> LUT-5UNV Lutron EcoSystem 5% Dimming, 120-277V	<input type="checkbox"/> NR Narrow 40° Beam Angle	<input type="checkbox"/> CZ ⁴ Customized	<input type="checkbox"/> CZ ⁴ Customized	<input type="checkbox"/> EM-INT ¹² 6W Integrated EM Backup CEC Compliant
		<input type="checkbox"/> WM Wall Mount	<input type="checkbox"/> LE15 1,500 lumens		<input type="checkbox"/> 40 4000K	<input type="checkbox"/> LUT-1UNV Lutron EcoSystem 1% Dimming, 120-277V	<input type="checkbox"/> MD Medium 60° Beam Angle			<input type="checkbox"/> ES ⁶ Philips EasySense CPM SN200 Ceiling Mount Sensor
		<input type="checkbox"/> WMUP Wall Mount Up lighting	<input type="checkbox"/> LE20 2,000 lumens		<input type="checkbox"/> 50 ³ 5000K	<input type="checkbox"/> LUT-L3DUNV Lutron Hi-lume 3-Wire 1% Dimming, 120-277V	<input type="checkbox"/> WD Wide 75° Beam Angle			<input type="checkbox"/> ENLS ⁷ -IL Enlighted Two Wire ENLIGHTED ONE Compact Sensor
			<input type="checkbox"/> LE25 2,500 lumens			<input type="checkbox"/> ELD-E010UNV EldoLED ECOdrive 0-10V 1%, 120-277V				<input type="checkbox"/> ENLS ⁷ -CL Enlighted Two Wire CONNECTED LIGHTING Compact Sensor
			<input type="checkbox"/> LE30 3,000 lumens			<input type="checkbox"/> ELD-EDALIUNV EldoLED ECOdrive DALI 1%, 120-277V				<input type="checkbox"/> ENLS ⁷ -IOT Enlighted Two Wire IOT Compact Sensor
			<input type="checkbox"/> LE40 4,000 lumens			<input type="checkbox"/> ELD-S010UNV EldoLED SOLOdrive 0-10V 0.1%, 120-277V				<input type="checkbox"/> WET ¹⁰ Wet Location Ready
			<input type="checkbox"/> LE50 ⁹ 5,000 lumens			<input type="checkbox"/> ELD-SDALIUNV EldoLED SOLOdrive DALI 0.1%, 120-277V				
						<input type="checkbox"/> OSRDIM010347V Osram OPTOTRONIC 0-10V 1%, 347V				

¹ Cable and Pendant Mount ready for Stem or Cable Suspension, order Canopy type and length separately. ² TRUE CHROMA only available for 3000K, contact factory for detail and other CCT. ³ 2700K and 5000K are not standard CCT and might be subjected to longer lead time, contact factory for detail. ⁴ Please contact factory for customized finish color or customized reflectors for feasibility. ⁵ Emergency units are not integrated and required clearance for external installation and additional single gang J-box, provided by other, for test button face plate installation. ⁶ Philips EasySense ceiling mounted sensor is only available with the PSRUNV driver. ⁷ Enlighted Two Wire Compact Sensor with ceiling mount is only available with the PSRUNV driver. ⁸ LE05 is not available with LUT-5UNV. ⁹ LE50 is not available with LUT-5UNV and LUT-1UNV. ¹⁰ WET location are available only for Surface Mounted and Wall Mount downlighting under covered ceiling. ¹¹ SP optic is not available with LEL model. ¹² EM-INT is integrated Emergency unit, factory installed, with test button on the Cylinder. Fixture with EM-INT should be installed in a controlled environment with ambient temperature not exceeding 77°F (25°C).



PXCYL CYLINDER 6"

MOUNTING AND CANOPY ACCESSORIES AND OPTIONS

ORDERING EXAMPLE: **STEMSCCPY/3-8/WH/12/18/3**

EX.: **STEM/3-8/12/WH**

CABLECPY / / 50 /				STEM/3-8 / /		
Model Series	Color	Length ³	Cord Type	Stem ²	Length	Finish
<input type="checkbox"/> CABLECPY¹ Cable mount canopy for flat and slope ceiling (use with CM mounting only)	<input type="checkbox"/> WH White	<input type="checkbox"/> 50 Adjustable length up to 50" max.	<input type="checkbox"/> 18/3 3 x 18 AWG, for non Dimming or TRIAC/ELV	<input type="checkbox"/> STEM/3-8 Stem (3/8 IPS)	<input type="checkbox"/> 12 12" long	<input type="checkbox"/> WH White
	<input type="checkbox"/> BL Black		<input type="checkbox"/> 18/3-22/2 3 x 18 AWG, 2 x 22 AWG (purple, pink), for 0-10V control and dimming		<input type="checkbox"/> 24 24" long	<input type="checkbox"/> BL Black
	<input type="checkbox"/> CZ⁴ Customized		<input type="checkbox"/> 18/4 4 x 18 AWG, for non Dimming or TRIAC/ELV emergency wiring		<input type="checkbox"/> 36 36" long	<input type="checkbox"/> CZ⁴ Customized
			<input type="checkbox"/> 18/4-22/2 4 x 18 AWG, 2 x 22 AWG, for emergency wiring and 0-10V control and dimming		<input type="checkbox"/> 48 48" long	
/ / /						
<input type="checkbox"/> STEMSCCPY/3-8^{1,2} Pendant stem Canopy (3/8 IPS) for flat and slope ceiling up to 45° (use with PM mounting only)	<input type="checkbox"/> WH White	<input type="checkbox"/> (Blank) Leave blank if you don't need power cord	<input type="checkbox"/> (Blank) Leave blank if you don't need power cord			
<input type="checkbox"/> STEMCDTFCCPY/3-8^{2,5} Jbox Cover Canopy for flat ceiling, with 4x side conduits pass through, for 3/8 IPS pendant stem	<input type="checkbox"/> BL Black	<input type="checkbox"/> 12 12" long	<input type="checkbox"/> 18/3 3 x 18 AWG, for non Dimming or TRIAC/ELV		<input type="checkbox"/> 48 48" long	
	<input type="checkbox"/> CZ⁴ Customized	<input type="checkbox"/> 24 24" long	<input type="checkbox"/> 18/3-22/2 3 x 18 AWG, 2 x 22 AWG (purple, pink), for 0-10V control and dimming			
		<input type="checkbox"/> 36 36" long	<input type="checkbox"/> 18/4 4 x 18 AWG, for non Dimming or TRIAC/ELV emergency wiring			
		<input type="checkbox"/> 48 48" long	<input type="checkbox"/> 18/4-22/2 4 x 18 AWG, 2 x 22 AWG, for emergency wiring and 0-10V control and dimming		<input type="checkbox"/> CZ⁴ Customized	
		<input type="checkbox"/> CZ⁴ Customized				

¹ The Stem and cable canopies can be used for both plane and slope ceiling. ² Stem to be ordered separately. ³ Cord length will be approximately 12" longer than cable or Stem.
⁴ Please contact factory for customized color and length. ⁵ Stem Conduit Canopy only available for flat ceiling.

LINE DRAWINGS

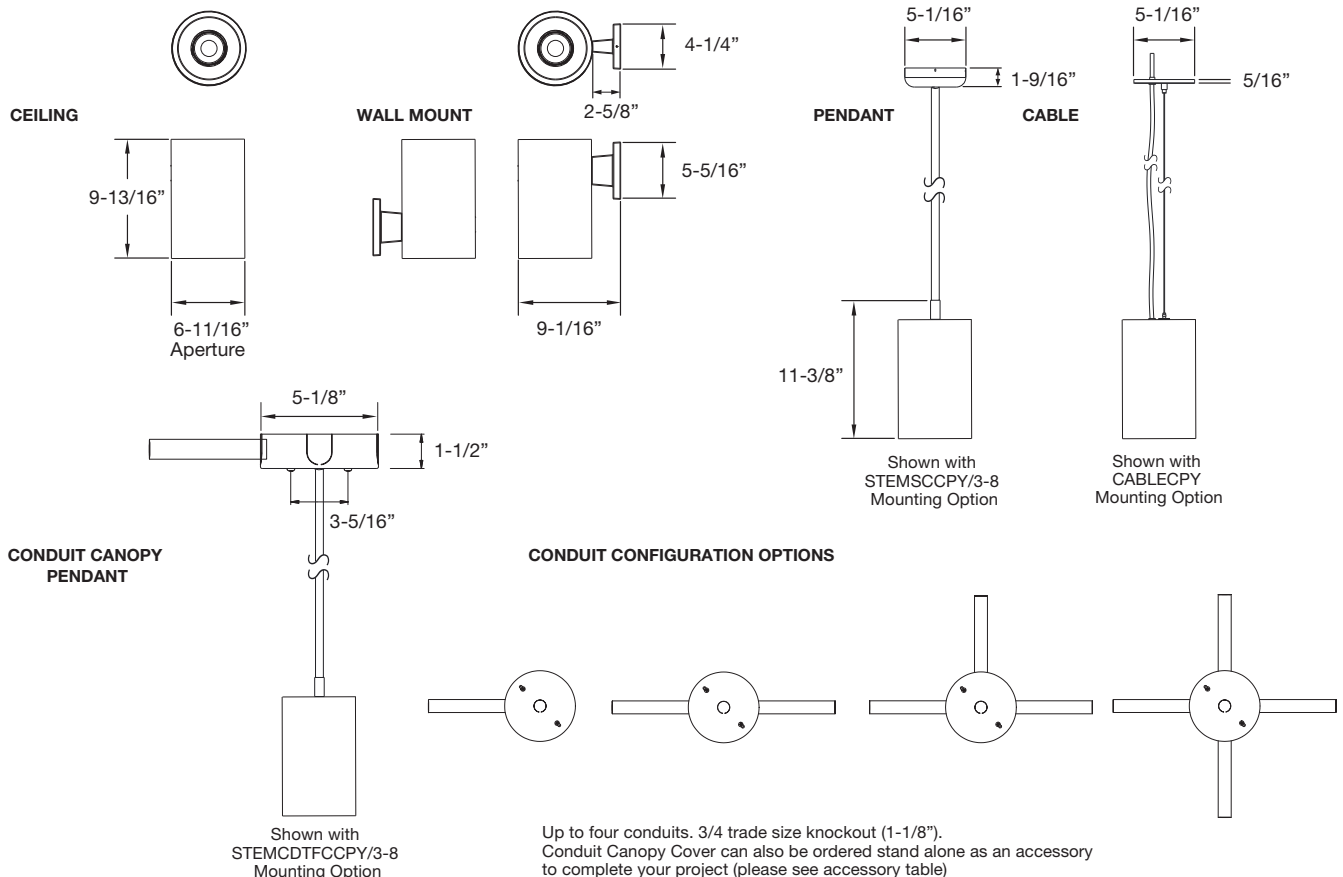



PXCYL CYLINDER 6"

LINE DRAWINGS WITH OPTIONS

WITH EM OR EM-CEC

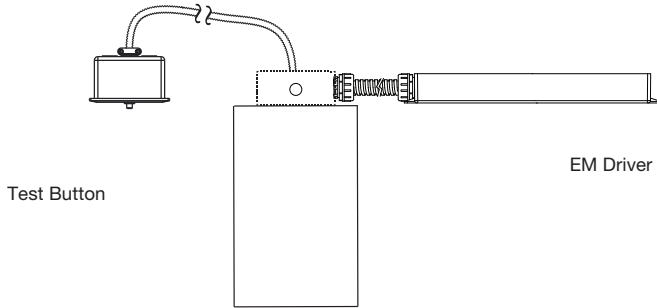

Field installable remote EM driver and Test button shown in surface mount installation. Electrical Box and Single gang j-box by others. Consult factory for additional options.

WITH SENSOR

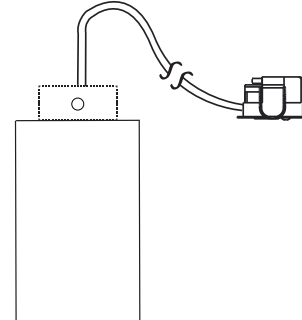

Philips EasySense sensor shown in Surface mount installation. Enlighted compact sensor also available. Consult factory for additional options.

WITH EM-INT

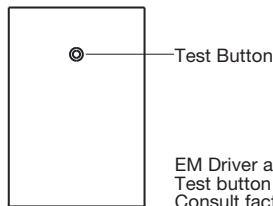

EM Driver and Test button are integrated in the Cylinder and Factory installed. Test button is located on the upper part of the cylinder. Consult factory for additional options.

ACCESSORY ORDERING INFORMATION

Product	Model	Description	Pictures	Dimensions
98079	ADWAW	Wall Wash (Field Installed on Module)		
36761	CONDUITCPYKIT/WH	White finish, decorative Jbox cover, with 4 side conduit pass-through.		 1/2 Trade size knockout (7/8\"/> 3-5/16\""/>
36762	CONDUITCPYKIT/BL	Black finish, decorative Jbox cover, with 4 side conduit pass-through.		 3/4 Trade size knockout (1-1/8\""/>

TECHNICAL INFORMATION

Light Engine	Input Voltage	Input Frequency	Input Current	Max. Input Power	THD Power	Power Factor
LES	120-277V	50-60Hz	0.115 / 0.047A	13W	<20%	>0.9
LEM			0.270 / 0.114A	31.5W		
LE05			0.056 / 0.024A	6.5W		
LE07			0.073 / 0.034A	8.5W		
LE10			0.112 / 0.047A	13W		
LE15			0.154 / 0.068A	18W		
LE20			0.218 / 0.092A	25.5W		
LE25			0.269 / 0.116A	31.5W		
LE30			0.318 / 0.133A	37.5W		
LE40			0.411 / 0.165A	48.5W		
LE50			0.487 / 0.203A	57.5W		



PXCYL CYLINDER 6"

NOMINAL PERFORMANCE

LES (LE05 / LE07 / LE10) - Low / Medium / High - 6.5 / 8.5 / 12.5W

CCT	2700K			3000K			3500K			4000K			5000K		
Output**	Low	Medium	High	Low	Medium	High	Low	Medium	High	Low	Medium	High	Low	Medium	High
Finish	lm LPW	lm LPW	lm LPW	lm LPW	lm LPW	lm LPW	lm LPW	lm LPW	lm LPW	lm LPW	lm LPW	lm LPW	lm LPW	lm LPW	lm LPW
Clear Diffuse	500 77	700 82	1,000 80	525 81	735 86	1,050 84	550 85	770 91	1,100 88	575 88	805 95	1,150 92	580 89	810 95	1,165 93
White Finish	500 77	700 82	1,000 80	525 81	735 86	1,050 84	550 85	770 91	1,100 88	575 88	805 95	1,150 92	580 89	810 95	1,165 93

LEM (LE15 / LE20 / LE25) - Low / Medium / High - 18.0 / 25.5 / 31.5W

CCT	2700K			3000K			3500K			4000K			5000K		
Output**	Low	Medium	High	Low	Medium	High	Low	Medium	High	Low	Medium	High	Low	Medium	High
Finish	lm LPW	lm LPW	lm LPW	lm LPW	lm LPW	lm LPW	lm LPW	lm LPW	lm LPW	lm LPW	lm LPW	lm LPW	lm LPW	lm LPW	lm LPW
Clear Diffuse	1,600 89	2,125 83	2,500 79	1,632 91	2,169 85	2,550 81	1,664 92	2,210 87	2,600 83	1,696 94	2,253 88	2,650 84	1,713 95	2,275 89	2,677 85
White Finish	1,600 89	2,125 83	2,500 79	1,632 91	2,169 85	2,550 81	1,664 92	2,210 87	2,600 83	1,696 94	2,253 88	2,650 84	1,713 95	2,275 89	2,677 85

LEL (LE30 / LE40 / LE50) - Low / Medium / High - 37.5 / 48.5 / 60.0W

CCT	2700K			3000K			3500K			4000K			5000K		
Output**	Low	Medium	High	Low	Medium	High	Low	Medium	High	Low	Medium	High	Low	Medium	High
Finish	lm LPW	lm LPW	lm LPW	lm LPW	lm LPW	lm LPW	lm LPW	lm LPW	lm LPW	lm LPW	lm LPW	lm LPW	lm LPW	lm LPW	lm LPW
Clear Diffuse	3,325 69	4,085 84	4,750 79	3,360 90	4,080 84	4,800 80	3,500 93	4,250 88	5,000 83	3,640 97	4,420 91	5,200 87	3,640 97	4,420 91	5,200 87
White Finish	3,325 69	4,085 84	4,750 79	3,360 90	4,080 84	4,800 80	3,500 93	4,250 88	5,000 83	3,640 97	4,420 91	5,200 87	3,640 97	4,420 91	5,200 87

** Lumen output are based on rated lumens, for exact value please refer to the IES files

PHOTOMETRY

PXCYL6/xx/LES9035/KDIM010UNV/SP/xx/WH (High Output)

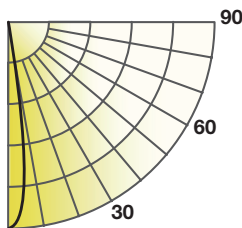

Lumens: 988 lm
CBCP: 4,721 cd
Power: 12 W
Efficacy: 82 lm/W
CRI: 92
Spacing Criteria: 0.3
Beam Angle: 18°

Candlepower Distribution	
Angle (°)	Average (cd)
10	1,928
20	532
30	306
40	93
50	11
60	1
70	0
80	0
90	0

Initial Footcandles		
Height (ft)	Fc	Diameter (ft)
8	45	3
10	29	3
12	20	4
15	13	5
20	7	6

Zonal Lumen Summary		
Zone	Lumens	%Fixt
0-30	815	85
0-40	880	89
0-60	981	99
0-90	987	100



PXCYL CYLINDER 6"

PHOTOMETRY

PXCYL6/xx/LES9035/KDIM010UNV/VN/xx/CC (High Output)

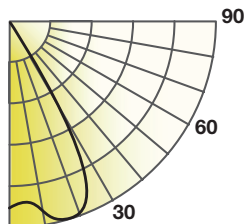

Lumens: 1,227 lm
CBCP: 1,383 cd
Power: 12 W
Efficacy: 102 lm/W
CRI: 92
Spacing Criteria: 0.5
Beam Angle: 27°

Candlepower Distribution	
Angle (°)	Average (cd)
10	1,313
20	1,254
30	673
40	289
50	7
60	1
70	0
80	0
90	0

Initial Footcandles		
Height (ft)	Fc	Diameter (ft)
8	30	4
10	20	5
12	14	6
15	9	7
20	5	10

Zonal Lumen Summary		
Zone	Lumens	%Fixt
0-30	971	79
0-40	1,201	98
0-60	1,226	100
0-90	1,160	90

PXCYL6/xx/LES9035/KDIM010UNV/NR/xx/CC (High Output)

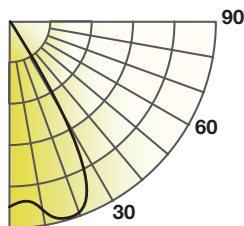

Lumens: 1,240 lm
CBCP: 1,397 cd
Power: 12 W
Efficacy: 103 lm/W
CRI: 92
Spacing Criteria: 1.1
Beam Angle: 44°

Candlepower Distribution	
Angle (°)	Average (cd)
10	1,326
20	1,266
30	727
40	146
50	7
60	2
70	0
80	0
90	0

Initial Footcandles		
Height (ft)	Fc	Diameter (ft)
8	31	6
10	20	8
12	14	10
15	9	12
20	5	16

Zonal Lumen Summary		
Zone	Lumens	%Fixt
0-30	981	79
0-40	1,213	98
0-60	1,238	99
0-90	1,239	100

PXCYL6/xx/LES9035/KDIM010UNV/MD/xx/CC (High Output)

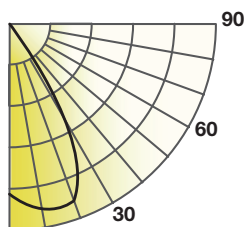

Lumens: 1,240 lm
CBCP: 1,397 cd
Power: 13 W
Efficacy: 103 lm/W
CRI: 92
Spacing Criteria: 0.90
Beam Angle: 62°

Candlepower Distribution	
Angle (°)	Average (cd)
10	1,327
20	1,267
30	722
40	143
50	6
60	2
70	0
80	0
90	0

Initial Footcandles		
Height (ft)	Fc	Diameter (ft)
8	31	10
10	20	12
12	14	15
15	9	18
20	5	24

Zonal Lumen Summary		
Zone	Lumens	%Fixt
0-30	981	79
0-40	1,213	98
0-60	1,238	100
0-90	1,239	100



PXCYL CYLINDER 6"

PHOTOMETRY

PXCYL6/xx/LES9035/KDIM010UNV/WD/xx/CC (High Output)

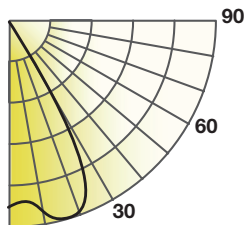

Lumens: 1,227 lm
CBCP: 1,439 cd
Power: 12 W
Efficacy: 102 lm/W
CRI: 92
Spacing Criteria: 1.1
Beam Angle: 82°

Candlepower Distribution	
Angle (°)	Average (cd)
10	1,361
20	1,304
30	743
40	151
50	7
60	2
70	0
80	0
90	0

Initial Footcandles		
Height (ft)	Fc	Diameter (ft)
8	32	14
10	20	17
12	14	21
15	9	26
20	5	35

Zonal Lumen Summary		
Zone	Lumens	%Fixt
0-30	1,010	79
0-40	1,249	98
0-60	1,275	100
0-90	1,276	100

PXCYL6/xx/LEM9035/KDIM010UNV/SP/xx/CC (High Output)

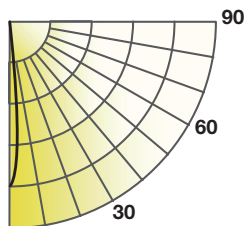

Lumens: 2,251 lm
CBCP: 11,979 cd
Power: 30 W
Efficacy: 71 lm/W
CRI: 92
Spacing Criteria: 0.3
Beam Angle: 18°

Candlepower Distribution	
Angle (°)	Average (cd)
10	503
20	139
30	66
40	22
50	3
60	1
70	0
80	0
90	0

Initial Footcandles		
Height (ft)	Fc	Diameter (ft)
8	12	3
10	7	3
12	5	4
15	3	5
20	2	6

Zonal Lumen Summary		
Zone	Lumens	%Fixt
0-30	1,903	85
0-40	2,155	96
0-60	2,243	100
0-90	2,250	100

PXCYL6/xx/LEM9035/KDIM010UNV/VN/xx/WH (High Output)

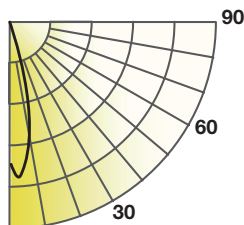

Lumens: 2,830 lm
CBCP: 11,387 cd
Power: 30 W
Efficacy: 91 lm/W
CRI: 92
Spacing Criteria: 0.4
Beam Angle: 22°

Candlepower Distribution	
Angle (°)	Average (cd)
10	599
20	266
30	67
40	9
50	1
60	0
70	0
80	0
90	0

Initial Footcandles		
Height (ft)	Fc	Diameter (ft)
8	14	3
10	9	4
12	6	5
15	4	6
20	2	8

Zonal Lumen Summary		
Zone	Lumens	%Fixt
0-30	2,612	92
0-40	2,780	98
0-60	2,825	100
0-90	2,829	100



PXCYL CYLINDER 6"

PHOTOMETRY

PXCYL6/xx/LEM9035/KDIM010UNV/NR/xx/CC (High Output)

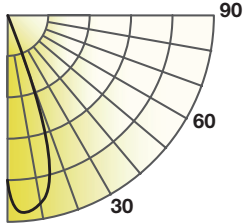

Lumens: 2,850 lm
CBCP: 6,278 cd
Power: 30 W
Efficacy: 91 lm/W
CRI: 92
Spacing Criteria: 0.6
Beam Angle: 41°

Candlepower Distribution	
Angle (°)	Average (cd)
10	5,750
20	3,304
30	917
40	75
50	11
60	3
70	1
80	0
90	0

Initial Footcandles		
Height (ft)	Fc	Diameter (ft)
8	134	6
10	85	7
12	59	9
15	38	11
20	21	15

Zonal Lumen Summary		
Zone	Lumens	%Fixt
0-30	2,644	93
0-40	2,818	99
0-60	2,846	100
0-90	2,848	100

PXCYL6/xx/LEM9035/KDIM010UNV/MD/xx/CC (High Output)

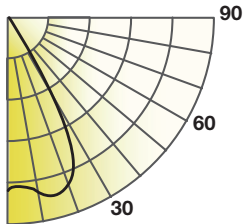

Lumens: 2,855 lm
CBCP: 3,356 cd
Power: 30 W
Efficacy: 90 lm/W
CRI: 92
Spacing Criteria: 0.9
Beam Angle: 61°

Candlepower Distribution	
Angle (°)	Average (cd)
10	3,156
20	2,954
30	1,605
40	263
50	15
60	5
70	2
80	0
90	0

Initial Footcandles		
Height (ft)	Fc	Diameter (ft)
8	73	9
10	47	12
12	33	14
15	21	18
20	12	24

Zonal Lumen Summary		
Zone	Lumens	%Fixt
0-30	2,307	80
0-40	2,801	98
0-60	2,849	100
0-90	2,852	100

PXCYL6/xx/LEM9035/KDIM010UNV/WD/xx/CC (High Output)

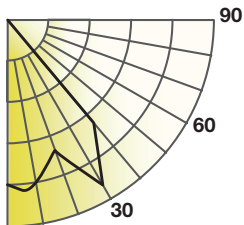

Lumens: 2,926 lm
CBCP: 2,352 cd
Power: 30 W
Efficacy: 94 lm/W
CRI: 92
Spacing Criteria: 1.2
Beam Angle: 80°

Candlepower Distribution	
Angle (°)	Average (cd)
10	1,841
20	1,751
30	2,234
40	1,069
50	36
60	10
70	4
80	1
90	0

Initial Footcandles		
Height (ft)	Fc	Diameter (ft)
8	43	13
10	27	17
12	19	20
15	12	25
20	7	33

Zonal Lumen Summary		
Zone	Lumens	%Fixt
0-30	1,612	55
0-40	2,654	91
0-60	2,912	100
0-90	2,922	100



PXCYL CYLINDER 6"

PHOTOMETRY

PXCYL6/xx/LEL9035/KDIM010UNV/VN/xx/CC (High Output)

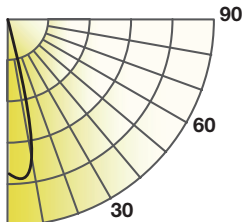

Lumens: 4,962 lm
CBCP: 11,865 cd
Power: 60 W
Efficacy: 90 lm/W
CRI: 92
Spacing Criteria: 0.5
Beam Angle: 32°

Candlepower Distribution	
Angle (°)	Average (cd)
10	852
20	483
30	193
40	26
50	5
60	2
70	1
80	0
90	0

Initial Footcandles		
Height (ft)	Fc	Diameter (ft)
8	20	5
10	13	6
12	9	7
15	6	9
20	3	11

Zonal Lumen Summary		
Zone	Lumens	%Fixt
0-30	4,347	88
0-40	4,809	97
0-60	4,941	100
0-90	4,957	100

PXCYL6/xx/LEL9035/KDIM010UNV/NR/xx/CC (High Output)

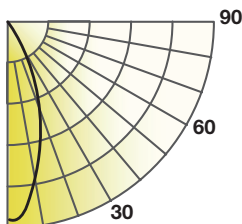

Lumens: 5,249 lm
CBCP: 9,786 cd
Power: 60 W
Efficacy: 95 lm/W
CRI: 92
Spacing Criteria: 0.7
Beam Angle: 45°

Candlepower Distribution	
Angle (°)	Average (cd)
10	7,983
20	5,461
30	2,357
40	211
50	33
60	11
70	4
80	1
90	0

Initial Footcandles		
Height (ft)	Fc	Diameter (ft)
8	185	7
10	119	8
12	82	10
15	53	12
20	30	16

Zonal Lumen Summary		
Zone	Lumens	%Fixt
0-30	4,524	86
0-40	5,153	98
0-60	5,234	100
0-90	5,244	100

PXCYL6/xx/LEL9035/KDIM010UNV/MD/xx/CC (High Output)

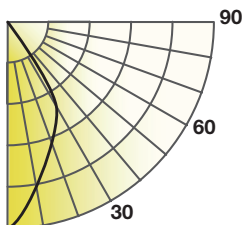

Lumens: 5,308 lm
CBCP: 7,096 cd
Power: 60 W
Efficacy: 96 lm/W
CRI: 92
Spacing Criteria: 0.8
Beam Angle: 57°

Candlepower Distribution	
Angle (°)	Average (cd)
10	6,222
20	4,634
30	3,246
40	716
50	40
60	13
70	5
80	1
90	0

Initial Footcandles		
Height (ft)	Fc	Diameter (ft)
8	145	9
10	92	11
12	64	13
15	41	16
20	23	22

Zonal Lumen Summary		
Zone	Lumens	%Fixt
0-30	3,975	75
0-40	5,138	97
0-60	5,291	100
0-90	5,302	100



PXCYL CYLINDER 6"

PHOTOMETRY

PXCYL6/xx/LEL9030/KDIM010UNV/WD/xx/CC (High Output)

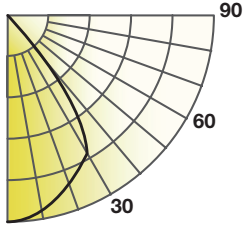

Lumens: 5,419 lm
 CBCP: 4,575 cd
 Power: 60 W
 Efficacy: 98 lm/W
 CRI: 92
 Spacing Criteria: 1.1
 Beam Angle: 72°

Candlepower Distribution	
Angle (°)	Average (cd)
10	4,277
20	4,119
30	3,539
40	1,539
50	96
60	29
70	11
80	4
90	0

Initial Footcandles		
Height (ft)	Fc	Diameter (ft)
8	99	12
10	64	15
12	44	18
15	28	22
20	16	29

Zonal Lumen Summary		
Zone	Lumens	%Fixt
0-30	3,390	63
0-40	4,970	92
0-60	5,385	99
0-90	5,411	100

Note: All rights reserved. All sizes and specifications are subject to change at any time without notice.