

Project Name:	Type:
Part Number:	Date:

# THINFIT 4" COMMERCIAL DOWNLIGHT

## SPECIFICATION FEATURES

- **Mechanical** - Shallow die cast aluminum heat sink with a low profile external driver is ideal for new or remodel construction. Two rugged spring clips allow for both easy installation and field accessibility below the ceiling.
- **Electrical** - Externally mounted driver, 120 - 277V voltage, 50/60Hz, 0 - 10V dimming to 10%. Quick connect electrical connect in metal clad cable. Go to [www.greencreative.com](http://www.greencreative.com) for complete dimmer compatibility list.
- **Optical** - Edge lighting technology featuring a PMMA light guide plate and smooth polycarbonate lens ensures an even light emitting surface. Available in 3000K, 3500K and 4000K with a minimum of 90 CRI.
- **Thermal** - Die cast aluminum heat sink with its edge lighting design maximizes thermal dissipation. L70 rated lifetime of 50,000 hours. Fixture operating temperature: -4°F to 95°F (-25°C to 35°C)
- **Compliance and warranty** - ETL Classified and Listed for wet location. Certified air-tight per ASTM 283-04, IC rated for direct contact with insulation. 5 year parts warranty for complete fixture.



122724



## BENEFITS

- Quick and easy installation with spring action clip
- External driver with quick connector for easy wiring
- Suitable for shallow ceiling applications
- Install almost everywhere with Wet Location, IC and Air-tight ratings
- Edge lighting technology for gentle and smooth diffusion

## APPLICATIONS

- Commercial
- Residential
- Educational
- Hospitality
- Retail

## ORDERING INFORMATION

Series	Size	CRI	CCT	Driver
<input checked="" type="checkbox"/> <b>10NCDL</b> New Construction Downlight 10W	<input checked="" type="checkbox"/> <b>R4DIM</b> 4"	<input checked="" type="checkbox"/> <b>9</b> CRI 90	<input type="checkbox"/> <b>30</b> 3000K <input type="checkbox"/> <b>35</b> 3500K <input type="checkbox"/> <b>40</b> 4000K	<input checked="" type="checkbox"/> <b>277V / EXT</b> 120 - 277V, 0-10V Dimmable to 10%

## LINE DRAWINGS

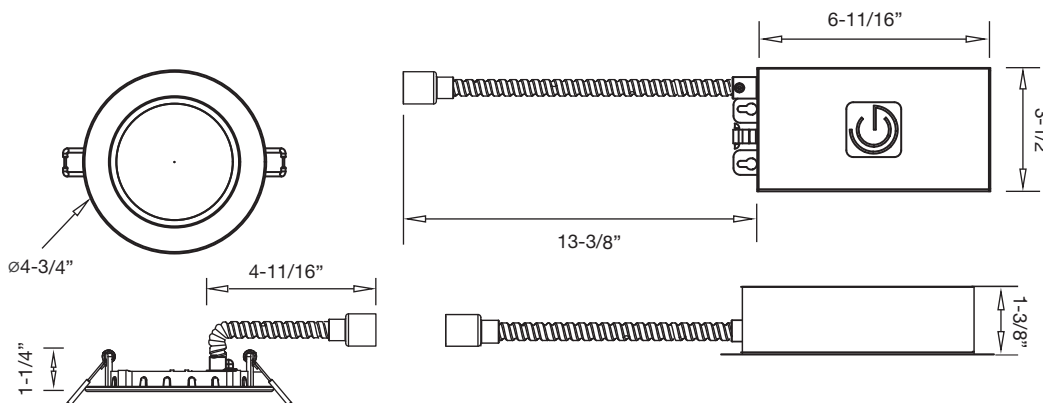

Ceiling Cutout	
Minimum	Maximum
$\varnothing 4-1/16"$	$\varnothing 4-3/8"$



# THINFIT 4" COMMERCIAL DOWNLIGHT

## TECHNICAL INFORMATION

Dimming	Input Voltage	Input Frequency	Input Current	Input Power	THD Power	Power Factor
0-10V	120-277V	50 / 60Hz	0.08A	10W	<20%	>0.9

## PHOTOMETRY

10NCDLR4DIM/935/277V/EXT

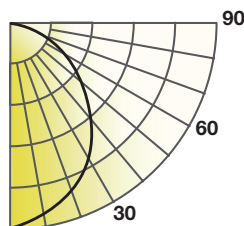

Lumens: 769 lm  
 Power: 9 W  
 Efficacy: 84 lm/W  
 CRI: 90+  
 Spacing Criteria: 1.26  
 Beam Angle: 100°

Candlepower Distribution	
Angle (°)	Average (cd)
0	265
5	264
15	255
25	237
35	211
45	180
55	142
65	101
75	57
85	13
90	0

Initial Footcandles		
Height (ft)	Fc	Diameter (ft)
8	4	25
9	3	28
10	3	31
12	2	37
15	1	46

Zonal Lumen Summary		
Zone	Lumens	%Fixture
0-30	208	27
0-40	338	44
0-60	600	78
0-90	769	100

Coefficient		
3000K	3500K	4000K
0.94	1.00	1.02

## PERFORMANCE











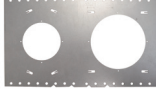
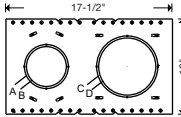
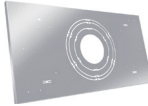
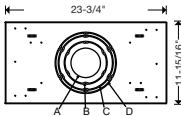

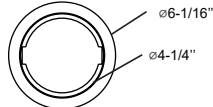
10NCDLR4DIM/9xx/277V/EXT

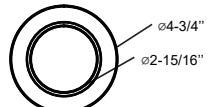
CCT	3000K	3500K	4000K
Lumens	726	769	781
LPW	79	84	85

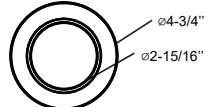
## ORDERING GUIDE

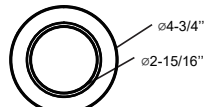
Product	Model
98215	10NCDLR4DIM/935/277V/EXT
98216	10NCDLR4DIM/940/277V/EXT

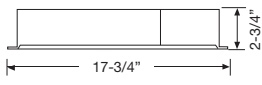
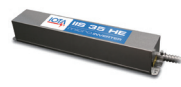
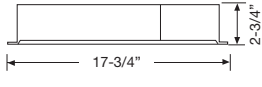
# THINFIT 4" COMMERCIAL DOWNLIGHT

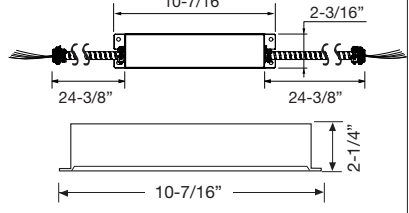
ACCESSORY ORDERING INFORMATION				
Product	Model	Description	Pictures	Dimensions
98280	NCDL46RPLATE	4" & 6" THINFIT EXT Series New Construction Plate for Stud/Joist Mounting		 A: Ø4-5/8" B: Ø4-3/16" C: Ø6-7/16" D: Ø6"
98501	NCPLATE/T4689	New Construction or Remodel Plate for T-Grid Ceilings		 A: Ø4-5/16" B: Ø6-5/16" C: Ø8-1/16" D: Ø9"
97847	DLNC4GOOF/R	4" THINFIT EXT Series GOOF RING		 Ø6-1/16" Ø4-1/4"
98345	NCDLR4TRIMBL	4" THINFIT EXT Series Black Trim		 Ø4-3/4" Ø2-15/16"
98346	NCDLR4TRIMBN	4" THINFIT EXT Series Brushed Nickel Trim		 Ø4-3/4" Ø2-15/16"
98347	NCDLR4TRIMBZ	4" THINFIT EXT Series Bronze Trim		 Ø4-3/4" Ø2-15/16"
58012	35EMINVERTER	35W Emergency Inverter (Field Installation)		 17-3/4" 2-3/4"
58013	35EMINVERTER/CEC	California Title 20 Compliant 35W Emergency Inverter (Field Installation)		 17-3/4" 2-3/4"
98003	23EMDRIVER	California Title 20 Compliant 23W Emergency LED Driver (Field Installation)		 10-7/16" 2-3/16" 24-3/8" 24-3/8" 2-1/4"

Note: All rights reserved. All sizes and specifications are subject to change at any time without notice.