



GREENCREATIVE

 LUMINAIRES



**CATALOG**



GREENCREATIVE

### Your partner for professional lighting solutions

GREEN CREATIVE, founded in 2010, is a solid-state lighting development and manufacturing company based in Sanford, FL with an office in Shanghai. The company offers a comprehensive line of high-performance LED Lamp, Downlight and Track lighting solutions, widely adopted by some of the largest companies in the world.



### Bringing you the latest in LED technology

Anchored by strong integrated R&D capabilities and patented technology, Our innovation, performance and reliability have been recognized year after year by the Illuminating Engineering Society Progress Report, the LEDs Magazine Sapphire Awards, Edison Report, NAILD and more.



### A complete line with national & international distribution

GREEN CREATIVE's full product line of ENERGY STAR®, DLC®, TITLE 20 & JA8 certified indoor retrofit and new construction lighting solutions serves the Retail, Hospitality, Food & Beverage, Office, Education & Industrial sectors through multiple distribution centers and sales networks across the USA.

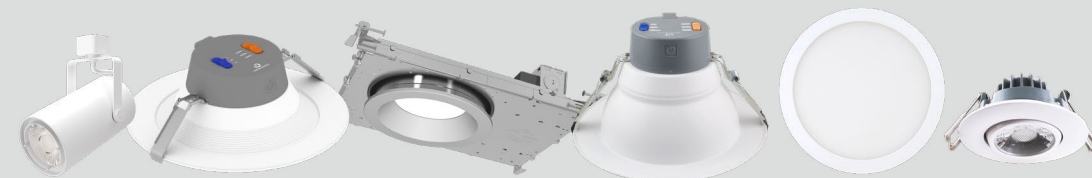

# TABLE OF CONTENTS

# 2024 FEATURED PRODUCTS

## COMMERCIAL & CYLINDER DOWNLIGHTING P1-28



PXCYL  
P1-2



SPECFIT  
P3-6

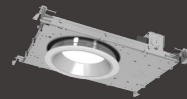

NYX  
P7-10



SELECTFIT  
P11-14



INNOFIT  
P15-18



MULTIFIT  
P19-20



MINIFIT  
P21-24



THINFIT EXT  
P25-26



THINFIT  
P27-28

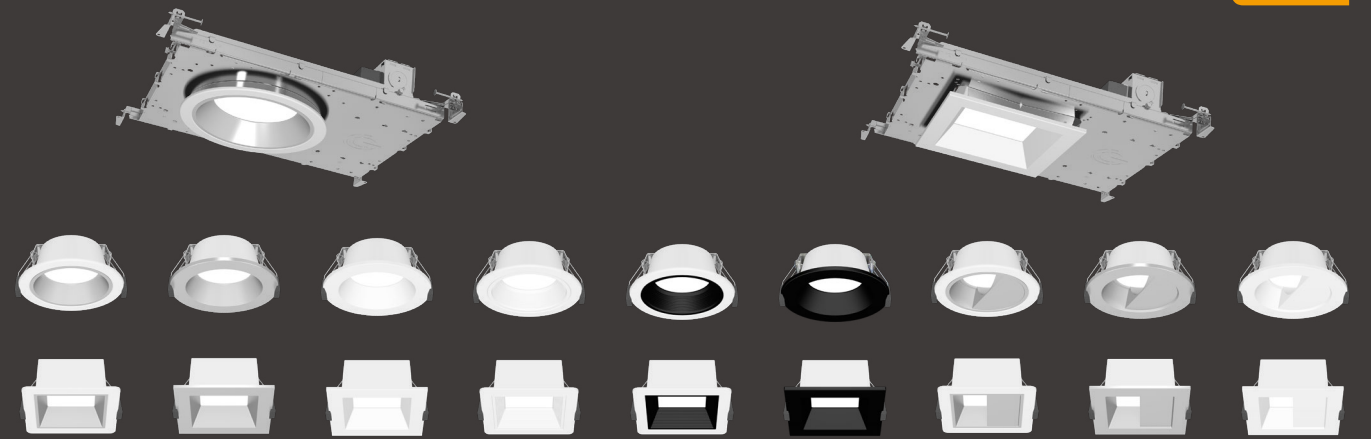

NEW!

P7-10

### NYX New Construction Downlight

- Abundant options of reflector finishes and optics
- Selectable color temperatures
- Selectable lumen outputs
- DualDim for either TRIAC/ELV or 0-10V controls

## SURFACE DOWNLIGHTING P29-36



3N1  
P29-30



CLICK WITH SENSOR  
P31-32



CLICK  
P33-34

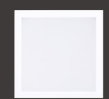

CLICK SQUARE  
P35-36

## RESIDENTIAL DOWNLIGHTING P37-38



RDL  
P37-38

## TRACK P39-50

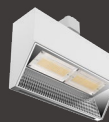

NOVA  
P39-42



ORBIT  
P43-44



ATOM  
P45-46



SOL  
P47-48



TRACK SYSTEM  
P49-50



NEW!

P39-42

### NOVA Track

- Three field selectable lumen output
- Three field selectable CCTs
- Sleek close-to-the-track design
- Uniform wide beam for top-to-bottom illumination across expansive surface



NEW!

P47-48

### SOL Track

- E26 medium base for easy front re-lamping
- 90° vertical aiming capability and 358° rotation
- Perfect companion with GREEN CREATIVE PAR Lamps
- Fully compatible with GREEN CREATIVE Track System

# PXCYL CYLINDER DOWNLIGHT



## Comprehensive Mounting Choices

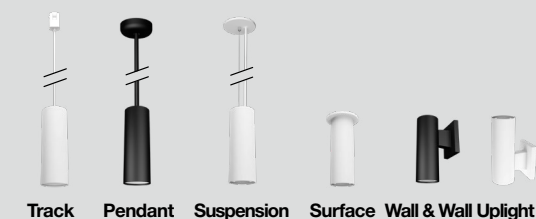

## Multiple Sizes



## Various Colors

### Cylinder Finishes



### Reflector Colors



Please contact factory for customized finish and reflector options

## SPECIFICATIONS

Frame Housing	Mounting	Light Engine <sup>1</sup>	CRI	CCT	Driver	Optical Distribution	Cylinder Finish	Reflector Finish	Options
PXCYL2 2" PXCYL Cylinder	SM Surface Mount	SelectDrive Light Engines <b>LES</b> Small Light Engine 500-700-1000 lumens	90 90+ CRI	27 <sup>5</sup> 2700K	SelectDrive Drivers <b>KDIM120V</b> SelectDrive 120V, 50/60Hz Forward/ Reverse phase dimming	SP Spot 15°	WH Matte White	CC Clear	EM-INT <sup>7</sup> 6W Integrated EM Backup CEC Compliant
PXCYL4 4" PXCYL Cylinder	CM <sup>2</sup> Cable Mount Ready	<b>LEM</b> Medium Light Engine 1500-2000-2500 lumens	97 <sup>4</sup> 97 CRI 3000K only	30 3000K	<b>KDIM010UNV</b> SelectDrive 120-277V, 50/60Hz 0-10V dimming	VN Very Narrow 25°	BL Matte Black	WH White	WET <sup>11</sup> Wet Location Ready
PXCYL6 6" PXCYL Cylinder	PM <sup>2</sup> Pendant Mount Ready	<b>LEL</b> Large Light Engine 3000-4000-5000 lumens		35 3500K	<b>PSRUNV</b> 0-10V Driver + SR Ready Bridge, 120-277V	NR Narrow 40°	CZ <sup>6</sup> Customized	CZ <sup>6</sup> Customized	ES <sup>8</sup> Philips EasySense ceiling mount sensor
PXCYL8 8" PXCYL Cylinder	WM Wall Mount	<b>LE05</b> 500 lumens		40 4000K	<b>XT010UNV</b> Signify 0-10V Driver 1% Dimming, 120-277V	MD Medium 60°			ENLS <sup>9</sup> - IL Enlighted Two Wire ENLIGHTED ONE Compact Sensor
	WMUP <sup>10</sup> Wall Mount Up Lighting	<b>LE07</b> 700 lumens			<b>LUT-1UNV</b> Lutron EcoSystem 1% Dimming, 120-277V	WD Wide 75°			ENLS <sup>9</sup> - CL Enlighted Two Wire CONNECTED LIGHTING Compact Sensor
		<b>LE10</b> 1000 lumens		50 <sup>5</sup> 5000K	<b>LUT-5UNV</b> Lutron EcoSystem 5% Dimming, 120-277V				ENLS <sup>9</sup> - IOT Enlighted Two Wire IOT Compact Sensor
		<b>LE15</b> 1500 lumens			<b>LUT-L3DUNV</b> Lutron Hi-Lume 3-Wire 1% Dimming, 120-277V				
		<b>LE20</b> 2000 lumens			<b>ELD-E010UNV</b> EldoLED ECOdrive 0-10V 1%, 120-277V				
					<b>ELD-EDALIUNV</b> EldoLED ECOdrive DALI 1%, 120-277V				
					<b>ELD-S010UNV</b> EldoLED SOLoDrive 0-10V 0.1%, 120-277V				
					<b>ELD-SDALIUNV</b> EldoLED SOLoDrive DALI 0.1%, 120-277V				
					<b>OSRDIM010347V</b> Osram OPTOTRONIC 0-10V 1%, 347V				
	TJPM <sup>10</sup> Track J-Type Suspended Mount								

<sup>1</sup> Small light engine is available for 2", 4", 6" & 8" cylinders. Medium light engine is available for 4", 6" & 8" cylinders. Large light engine is available for 6" & 8" cylinders. <sup>2</sup> Cable and Pendant Mount ready for Stem or Cable Suspension, order Canopy type and length separately. <sup>3</sup> Fixed output light engines are only available with fixed output drivers. LE05 is not available with LUT-5UNV. LE50 is not available with LUT-5UNV and LUT-1UNV. <sup>4</sup> CRI97 TRUE CHROMA is available in 3000K only and may be subject to minimum order quantities. Please consult the factory for details. <sup>5</sup> 2700K and 5000K are not standard CCT and might be subjected to longer lead time, contact factory for detail. <sup>6</sup> Please contact factory for customized color or cable length for feasibility. <sup>7</sup> EM-INT is integrated Emergency unit, factory installed, with test button on the Cylinder. Available for 6" and 8" cylinders only. Fixture with EM-INT should be installed in a controlled environment with ambient temperature not exceeding 77°F (25°C). <sup>8</sup> Philips EasySense ceiling mounted sensor is only available with the PSRUNV driver. Not available for 2" cylinder. <sup>9</sup> Enlighted Two Wire Compact Sensor with ceiling mount is only available with the PSRUNV driver. Not available for 2" cylinder. <sup>10</sup> Only for 2" PXCYL cylinder. <sup>11</sup> WET locations are available only for Surface Mounted and Wall Mount downlighting under covered ceiling.

## Additional Controls

### Standard Drivers



### Driver & Control Options



## 5 Color Temperatures

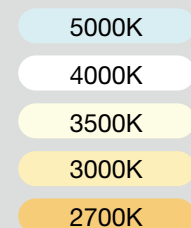

## 3 Lumen Packages

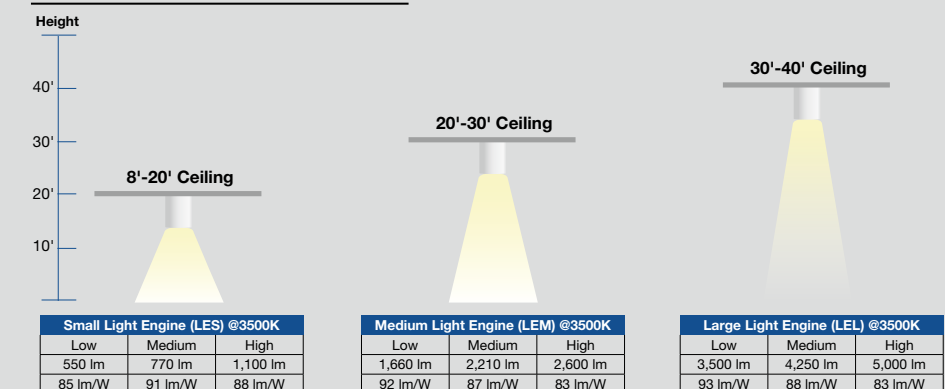

Note: Small light engine is available for 2", 4", 6" & 8" cylinders. Medium light engine is available for 4", 6" & 8" cylinders. Large light engine is available for 6" & 8" cylinders

## 5 Beam Angles

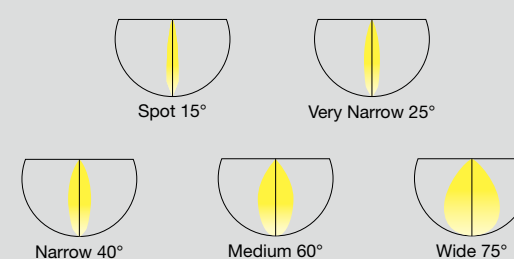

## Deep Cutoff

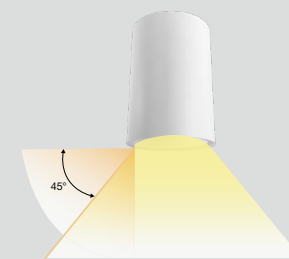

# SPECFIT RETROFIT COMMERCIAL DOWNLIGHT



## SPECIFICATIONS

### Light Engine and Driver

Light Engines	CRI	CCT	Driver	Optical Distribution	Options <sup>5</sup>
<b>SelectDrive Light Engines<sup>1</sup></b>	<b>90</b>	<b>27</b>	<b>SelectDrive Drivers</b>	<b>MD<sup>4</sup></b> Medium 60° (Installed Standard)	<b>SD347</b> 347V - 240V Step Down Transformer
<b>LES</b> Small Light Engine 500-700-1000 lumens	90+ CRI	2700K	<b>KDIM120V</b> 120V, 50/60Hz Forward/Reverse Phase dimming		
<b>LEM</b> Medium Light Engine 1500-2000-2500 lumens	<b>97<sup>3</sup></b> 97 CRI 3000K only	<b>30</b> 3000K	<b>KDIM010UNV</b> SelectDrive 120-277V, 50/60Hz 0-10V dimming	<b>SP</b> Spot 15°	<b>EM<sup>6</sup></b> 10.7W Emergency Backup
<b>LEL</b> Large Light Engine 3000-4000-5000 lumens		<b>35</b> 3500K	<b>Fixed Output Drivers</b>	<b>VN</b> Very Narrow 25°	<b>EM<sup>6</sup>-CEC</b> California Title 20 Compliant 10.7W Emergency Backup
<b>Fixed Output Light Engines<sup>2</sup></b>			<b>PSRUNV</b> 0-10V Driver + SR Ready Bridge, 120-277V	<b>NR</b> Narrow 40°	<b>OUT</b> Outdoor Debris Ingress Protection
<b>LE05</b> 500 lumens		<b>40</b> 4000K	<b>ELD-E010UNV</b> EldoLED ECOdrive 0-10V 1%, 120-277V	<b>WD</b> Wide 75°	<b>ES<sup>7</sup></b> Philips EasySense ceiling mount sensor
<b>LE07</b> 700 lumens			<b>XT010UNV</b> Signify 0-10V Driver 1% Dimming, 120-277V		<b>ENLS<sup>8</sup>-IL</b> Enlighted Two Wire Compact Sensor
<b>LE10</b> 1000 lumens		<b>50</b> 5000K	<b>LUT-1UNV</b> Lutron EcoSystem 1% Dimming, 120-277V		<b>ENLIGHTED ONE</b> Compact Sensor
<b>LE15</b> 1500 lumens			<b>LUT-5UNV</b> Lutron EcoSystem 5% Dimming, 120-277V		<b>ENLS<sup>8</sup>-CL</b> Enlighted Two Wire CONNECTED LIGHTING Compact Sensor
<b>LE20</b> 2000 lumens			<b>LUT-L3DUNV</b> Lutron Hi-lume 3-Wire 1% Dimming, 120-277V		<b>ENLS<sup>8</sup>-IOT</b> Enlighted Two Wire IOT Compact Sensor
			<b>ELD-EDALIUNV</b> EldoLED ECOdrive DALI 1%, 120-277V		<b>WET</b> Wet location option
			<b>ELD-S010UNV</b> EldoLED SOLOdrive 0-10V 0.1%, 120-277V		
			<b>ELD-SDALIUNV</b> EldoLED SOLOdrive DALI 0.1%, 120-277V		

### Reflector

#### Shape & Size

#### Finish

<b>ADR4</b> 4" Round	<b>ADS4<sup>10</sup></b> 4" Square	<b>ADR6</b> 6" Round	<b>ADS6<sup>10</sup></b> 6" Square	<b>CC</b> Clear Diffuse Trim and Flange	<b>WH</b> Matte White Trim and Flange
<b>ADR8</b> 8" Round	<b>ADR9.5</b> 9.5" Round	<b>CW</b> Clear Diffuse Trim, White Flange	<b>BL<sup>9</sup></b> Matte Black Trim and Flange		

## CHOICE OF MULTIPLE OPTICS

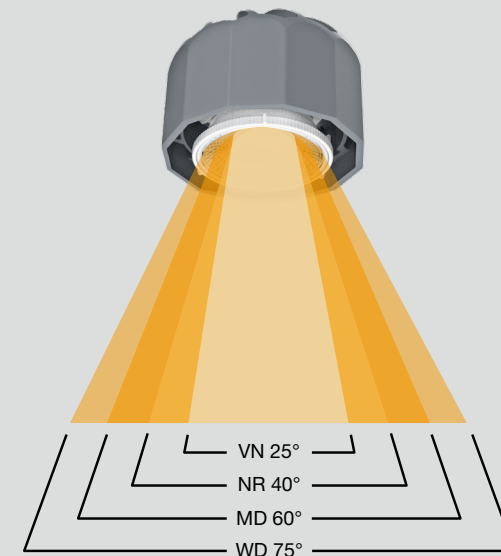

- Field interchangeable optics
- Selectable light output
- 97 CRI modules meet TRUE CHROMA standard
- Multiple reflector options - CC, CW, WH & BL

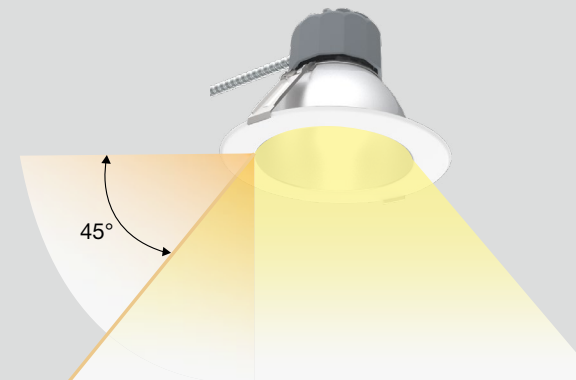

## OPTICAL CUTOFF

45° optical cutoff provide a quiet ceiling with minimal glare and maximum efficiency.

## SELECTABLE LIGHT OUTPUT



**LES & LEM**  
LES - 500/700/1000 Lumens  
LEM - 1500/2000/2500 Lumens



**LEL**  
LEL - 3000/4000/5000 Lumens



## SelectDrive Technology - Adjustable Lumen Output

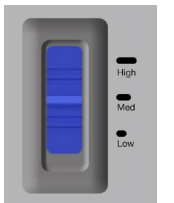
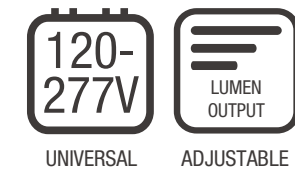

## ADDITIONAL CONTROLS

Take even more control of SPECFIT fixtures with a variety of control system options. These include the Lutron 5-Series Ecosystem driver which provides smooth dimming to 5% and the Lutron Hi-Lume 1% EcoSystem driver with Soft-On, Fade-to-Black which dims to 1%. EldoLED ECOdrive and SOLOdrive drivers available in 0-10V and DALI configurations and dim smoothly to 1% and 0.1% respectively. Additional sensors such as enlightened compact sensors and Philips EasySense sensors, can be field installed and directly integrate with the factory provided Philips Xitanium driver and Sensor Ready Bridge.



## ACCESSORIES

Product	Model	Description
98079	ADWAW	Wall Wash Accessory
98569	GOOFRING4	4" Goof Ring - Outer Diameter 8-1/8"
98568	GOOFRING6	6" Goof Ring - Outer Diameter 10-1/2"
98567	GOOFRING8	8" Goof Ring - Outer Diameter 12-1/2"
98566	GOOFRING9.5	9.5" Goof Ring - Outer Diameter 14-3/16"

<sup>1</sup> Small Light Engine is not available with the ADR9.5 reflector, Large Light Engine is not available with the ADR4 reflector. / <sup>2</sup> Fixed output light engines are only available with DIM120V, PSRUNV, LUT-5UNV, or LUT-1UNV dimming drivers. LE05 is not available with LUT-5UNV. LE50 is not available with LUT-5UNV and LUT-1UNV. LE30, LE40 and LE50 light engines are not available for use with ADR4 reflector. / <sup>3</sup> CRI97 TRUE CHROMA is available in 3000K only and may be subject to minimum order quantities. Please consult the factory for details. / <sup>4</sup> Medium Lens Optic comes installed as standard, alternate optics will ship separately and require field installation. / <sup>5</sup> Options are factory installed and come with the Light Engine and Driver. / <sup>6</sup> EM cannot be combined with SD347 or SD490 option. / <sup>7</sup> ES only available with PSRUNV Driver. / <sup>8</sup> Enlighted Two Wire Compact Sensor with ceiling mount is only available with the PSRUNV driver. / <sup>9</sup> The Black reflector is only available for ADR4 and ADR6 reflectors. / <sup>10</sup> ADS4 and ADS6 are available in CC and WH finishes only.

# SPECFIT NEW CONSTRUCTION DOWNLIGHT

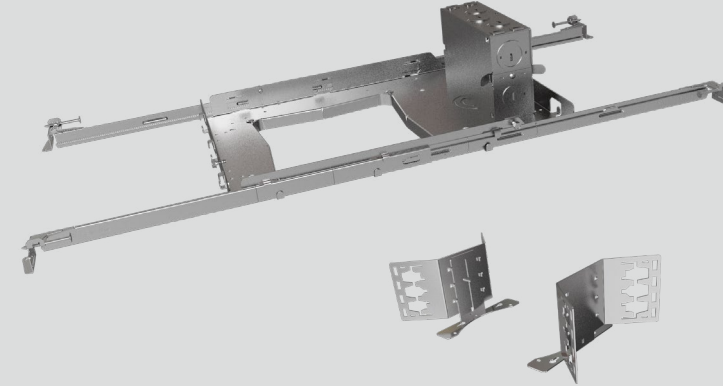
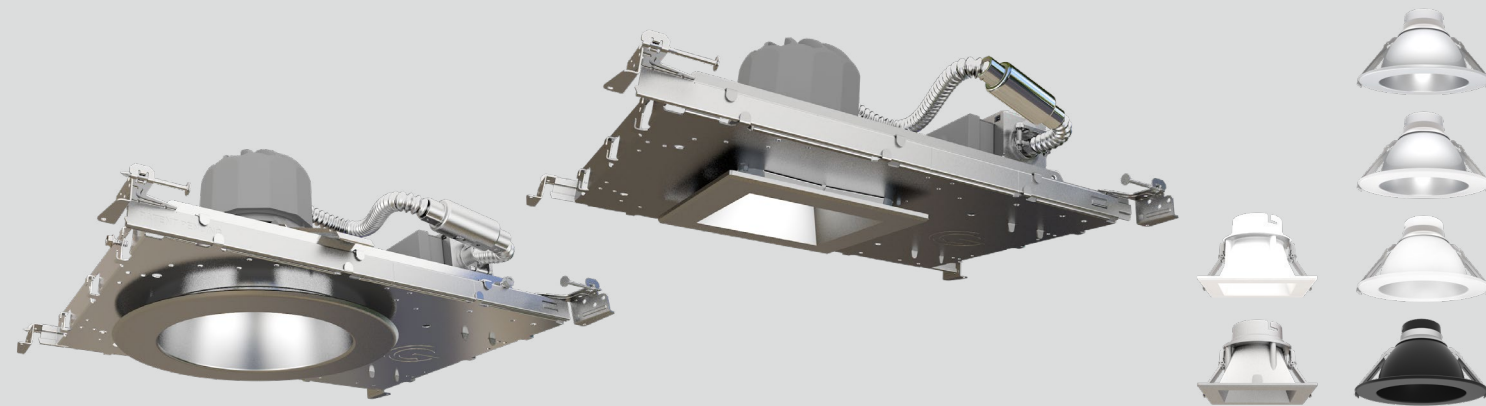

## NEW CONSTRUCTION FRAME

The SPECFIT new construction frames, made of the highest quality galvanized steel, are designed to be installed in suspended T-grid or wood joist ceilings. The low profile bar hangers with non-pass through construction and leveling flanges contain an integral tee bar clip and preinstalled nail, quick and safe installation in standard 2x2' and 2x4' suspended ceilings. The attached junction box and prewired driver, with quick connect MC cable allows for easy fixture wiring. Optional field installable butterfly brackets are also available for C-Channel or conduit suspension. EM unit can be factory installed on demand with a specifically designed bracket.

## TRUE CHROMA

SPECFIT, powered by TRUE CHROMA technology, has the highest color accuracy standard in the market. TRUE CHROMA starts with a maximum 3 step SDCM LED light source. Then, based on the traditional CRI and new IES TM-30-15 standards, TRUE CHROMA delivers CRI ≥ 95, R9 ≥ 50 and Rf ≥ 93. Rest assured that new spaces lit with SPECFIT fixtures powered by TRUE CHROMA will look their best.

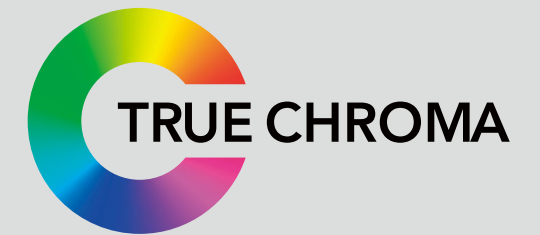

## SPECIFICATIONS

### Light Engine and Driver

Frame Housing	Light Engines	CRI	CCT	Driver	Optical Distribution	Options <sup>5</sup>
<b>SPFTR4</b> 4" SPECFIT Round New Construction	<b>SelectDrive Light Engines<sup>1</sup></b> <b>LES</b> Small Light Engine 500-700-1000 lumens	<b>90</b> 90+ CRI	<b>27</b> 2700K	<b>SelectDrive Drivers</b> <b>KDIM120V</b> 120V, 50/60Hz Forward/Reverse Phase dimming	<b>MD<sup>4</sup></b> Medium 60° (Installed Standard)	<b>SD347</b> 347V - 240V Step Down Transformer
<b>SPFTR6</b> 6" SPECFIT Round New Construction	<b>LEM</b> Medium Light Engine 1500-2000-2500 lumens	<b>97<sup>3</sup></b> 97 CRI 3000K only	<b>30</b> 3000K	<b>KDIM010UNV</b> SelectDrive 120-277V, 50/60Hz 0-10V dimming	<b>SP</b> Spot 15°	<b>EM<sup>6</sup></b> 10.7W Emergency Backup
<b>SPFTR8</b> 8" SPECFIT Round New Construction	<b>LEL</b> Large Light Engine 3000-4000-5000 lumens		<b>35</b> 3500K	<b>Fixed Output Drivers</b> <b>PSRUNV</b> 0-10V Driver + SR Ready Bridge, 120-277V	<b>VN</b> Very Narrow 25°	<b>EM<sup>6</sup>-CEC</b> California Title 20 Compliant 10.7W Emergency Backup
<b>SPFTR9.5</b> 9.5" SPECFIT Round New Construction	<b>Fixed Output Light Engines<sup>2</sup></b> <b>LE05</b> 500 lumens <b>LE25</b> 2500 lumens		<b>40</b> 4000K	<b>XT010UNV</b> Signify 0-10V Driver 1% Dimming, 120-277V	<b>NR</b> Narrow 40°	<b>OUT</b> Outdoor Debris Ingress Protection
<b>SPFTR9.5</b> 9.5" SPECFIT Round New Construction	<b>LE07</b> 700 lumens <b>LE30</b> 3000 lumens		<b>50</b> 5000K	<b>ELD-E010UNV</b> EldoLED ECOdrive 0-10V 1%, 120-277V	<b>WD</b> Wide 75°	<b>ES<sup>7</sup></b> Philips EasySense ceiling mount sensor
<b>SPFTR9.5</b> 9.5" SPECFIT Round New Construction	<b>LE10</b> 1000 lumens <b>LE40</b> 4000 lumens			<b>ELD-EDALIUNV</b> EldoLED ECOdrive DALI 1%, 120-277V		<b>ENLS<sup>8</sup>-IL</b> Enlighted Two Wire <b>ENLIGHTED ONE</b> Compact Sensor
<b>SPFTR9.5</b> 9.5" SPECFIT Round New Construction	<b>LE15</b> 1500 lumens <b>LE50</b> 5000 lumens			<b>ELD-S010UNV</b> EldoLED SOLOdrive 0-10V 0.1%, 120-277V		<b>ENLS<sup>8</sup>-CL</b> Enlighted Two Wire <b>CONNECTED LIGHTING</b> Compact Sensor
<b>SPFTR9.5</b> 9.5" SPECFIT Round New Construction	<b>LE20</b> 2000 lumens			<b>ELD-SDALIUNV</b> EldoLED SOLOdrive DALI 0.1%, 120-277V		<b>ENLS<sup>8</sup>-IOT</b> Enlighted Two Wire <b>IOT</b> Compact Sensor
<b>SPFTR9.5</b> 9.5" SPECFIT Round New Construction				<b>LUT-1UNV</b> Lutron EcoSystem 1% Dimming, 120-277V		<b>WET</b> Wet location option
<b>SPFTR9.5</b> 9.5" SPECFIT Round New Construction				<b>LUT-5UNV</b> Lutron EcoSystem 5% Dimming, 120-277V		
<b>SPFTR9.5</b> 9.5" SPECFIT Round New Construction				<b>LUT-L3DUNV</b> Lutron Hi-lume 3-Wire 1% Dimming, 120-277V		

### Reflector

#### Shape & Size

#### Finish

<b>ADR4</b> 4" Round	<b>ADS4<sup>10</sup></b> 4" Square	<b>ADR6</b> 6" Round	<b>ADS6<sup>10</sup></b> 6" Square	<b>CC</b> Clear Diffuse Trim and Flange	<b>WH</b> Matte White Trim and Flange
<b>ADR8</b> 8" Round	<b>ADR9.5</b> 9.5" Round	<b>CW</b> Clear Diffuse Trim, White Flange	<b>BL<sup>9</sup></b> Matte Black Trim and Flange		

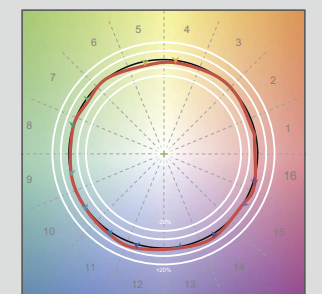
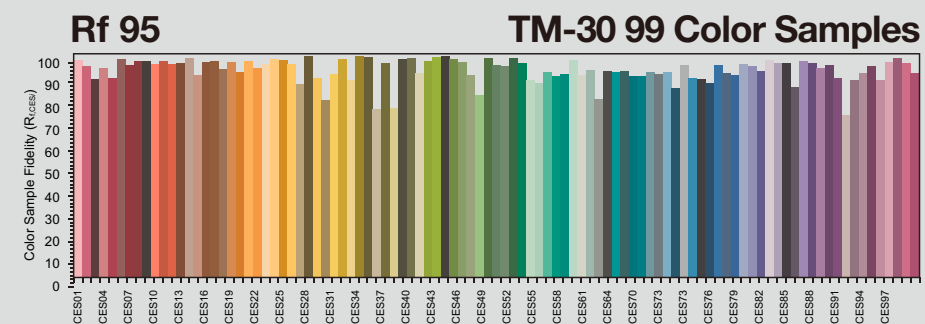

## ACCESSORIES

Product	Model	Description
98079	ADWAW	Wall Wash Accessory
35126	NCFBFB	Set of Two Field Installable Butterfly Brackets For New Construction Rough-in Frame
35125	NCFEMB	Field Installable Emergency Bracket For New Construction Rough-in Frame

<sup>1</sup> Small Light Engine is not available with the ADR9.5 reflector, Large Light Engine is not available with the ADR4 reflector. <sup>2</sup> Fixed output light engines are only available with fixed output drivers. LE05 is not available with LUT-5UNV. LE50 is not available with LUT-1UNV and LUT-5UNV. LE30, LE40 and LE50 light engines are not available for use with ADR4 reflector. <sup>3</sup> CRI97 TRUE CHROMA is available in 3000K only and may be subject to minimum order quantities. Please consult the factory for details. <sup>4</sup> Medium Lens Optic comes installed as standard, alternate optics will ship separately and require field installation. <sup>5</sup> Options are factory installed and come with the Light Engine and Driver. <sup>6</sup> EM cannot be combined with SD347 or SD480 option. <sup>7</sup> ES only available with PSRUNV Driver. <sup>8</sup> Enlighted Two Wire Compact Sensor with ceiling mount is only available with the PSRUNV driver. <sup>9</sup> The Black reflector is only available for ADR4 and ADR6 reflectors. <sup>10</sup> ADS4 and ADS6 are available in CC and WH finishes only.

# NYX NEW CONSTRUCTION DOWNLIGHT



DualDim

Select Drive  
Select Kelvin



## Downlighting Reborn

With integrated SelectDrive, SelectKelvin and DualDim technologies, abundant options of field installable accessories, and unique can-less compact design, NYX revives customized downlighting design in any new construction project.

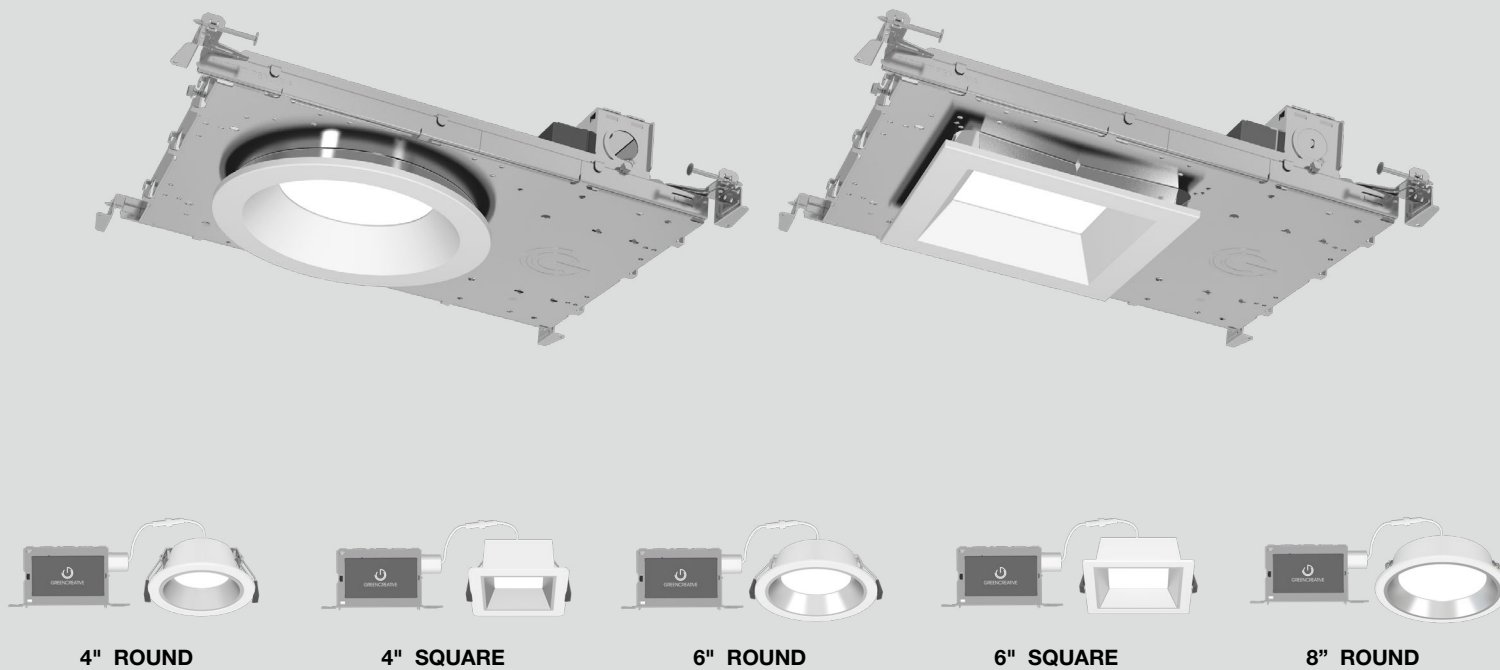

### Emergency Back-Up Option

- Factory Installed 6W EM Driver
- Field Installable 21W to 25W EM Inverters

### DualDim Driver

- 120-277V Input
- One driver suitable for both 0-10V and 120V TRIAC/ELV dimming systems



### Selectable CCT

Select Kelvin

- 2700K Soft White
- 3000K Warm White
- 3500K Neutral White
- 4000K Cool White
- 5000K Day Light

### Selectable Lumen Levels

Select Drive

	4" / 6" / 8" Small Engine	6" / 8" Medium Engine	8" Large Engine
High	2000lm	4000lm	6000lm
Med	1500lm	3000lm	5000lm
Low	1000lm	2500lm	4000lm
Extra Low	700lm		

### Lens

- Wide
- Medium

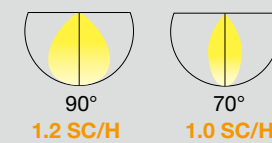

### Wall Wash

- Cut off degree of 30° (round) & 20° (square)
- White or clear finish

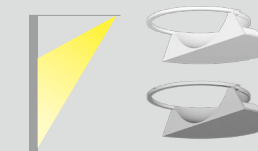

### Super Shallow Design

- Less than 4" depth on standard product

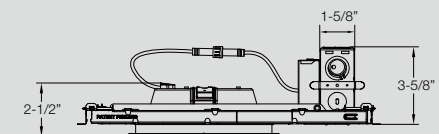

Direct Mount

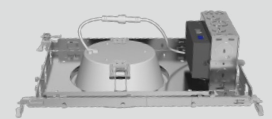

New Construction

### Reflector & Flange

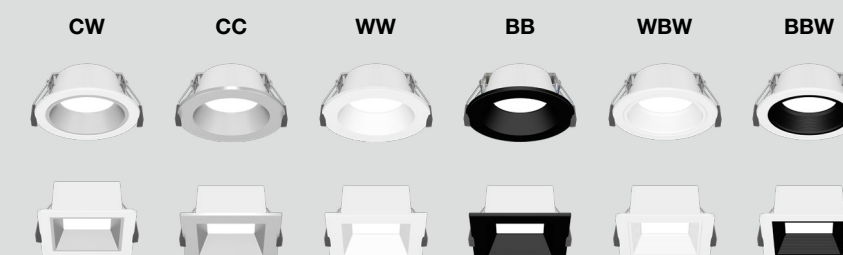

### Various Form Factors

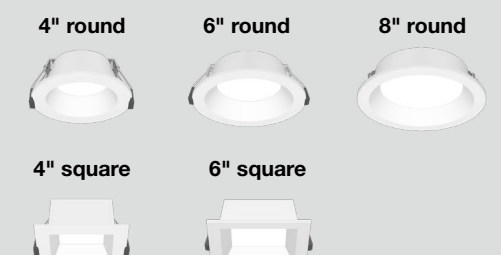

SPECIFICATIONS							
Series	Installation Type	Size	Style	Lumen	CRI	CCT	Driver
NYX NYX series downlights	NC New Construction Frame	4 4"	RD Round	S 700/1000/1500 /2000lm	9 90+ CRI	CCT5S Selectable CCT 2700K / 3000K / 3500K / 4000K / 5000K	DUALDIM 120V-277V, 50/60Hz. 0-10V or Forward/Reverse phase dimming at 120V only.
	ICAT New Construction With IC Cover	6 6"	SQ Square	M 2500/3000/ 4000lm			
	DM Direct Mount, Remodel	8 6"		L Large Selectable L/M/H 4000/5000/6000lm			
				Fxx Fixed Lumens xx= 07, 10, 15, 20, 25, 30, 40, 50, 60			
Optic		Reflector and Flange			Options		
WD Wide 90D Distribution 1.2 SC/H		CW Clear Reflector with White Flange			EM 6W Emergency LED Driver		
MD Medium 70D Distribution 1.0 SC/H		CC Clear Reflector with Clear Flange (Dead Front)			AWNRR Lutron Athena Node		
WW Wall Wash		WW White Reflector with White Flange (Dead Front)					
		BB Black Reflector with Black Flange (Dead Front)					
		WBW White Baffle Reflector with White Flange					
		BBW Black Baffle Reflector with White Flange					

Note: refer to product spec sheet for configuration details.

# NYX NEW CONSTRUCTION DOWNLIGHT

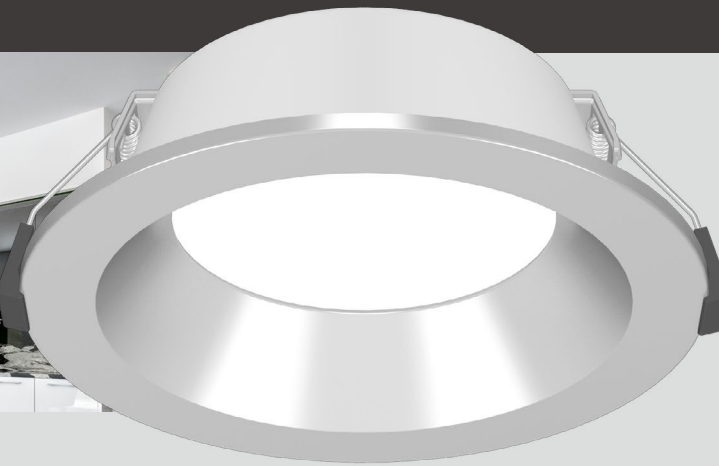

## Performance With Durability In Mind

NYX has been thought with performance in mind without compromising on design and allows for installing virtually anywhere. The products are engineered in a super shallow design of less than 4", IC and Air-Tight rated, suitable for wet locations, Energy Star certified and meeting Title 24 JA8 requirements. With calculated L70 of 100,000 hours, tight LED binning within 3 SDCM and high CRI 90, NYX downlights ensure uniform and vivid lighting for your space.

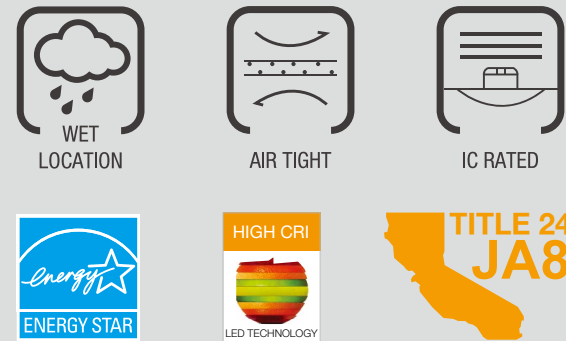

## Simplicity From Installation To Upgrade

NYX is designed with a complete toolless field installation doable in seconds, for both new construction or direct mount. All parts are upgradable or serviceable from below the ceiling. You can relax when installing a NYX downlight for both ease of maintenance or future upgrade if the space requires.

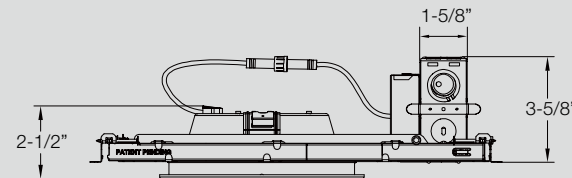

## Ready For Any Dimming Protocol

All NYX products are suitable for 120-277V input and feature our DualDim technology allowing the luminaire to be dimmed with either TRIAC/ELV or 0-10V controls. Taking the guesswork out of auditing an existing space and providing optimal flexibility while minimizing un-expected installation issues in the field. NYX is the right solution for all your projects in residential, commercial, mixed-use, new construction or remodel applications.



## Integrated CCTs and Lumens Options

### Select Kelvin

Utilizing our SelectKelvin technology, select the CCT before, during, or after installation with just the flip of a switch. Choose from 2700/3000/3500/4000 /5000K CCT to customize any application and set the right atmosphere for your space.

### Select Drive

Get the right amount of light with NYX powered by SelectDrive technology. Choose either Extra low, Low, Medium or High light output. With just the flip of a switch on the driver, NYX ensures that every space has just the right amount of light from 700lm to 4000lm.

### Selectable CCT

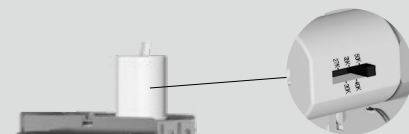

### Selectable Power Output

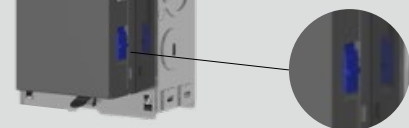

## A Solution For Different Height And Spacing

With NYX you can get the right amount of light for any project, ranging from smooth 700lm to powerful 6000lm, no matter your ceiling height and your plenum space thanks to its super shallow design, NYX is the right solution for your space. With different beam angle option in wide and medium distributions, NYX has a solution for each room size and height to offer an even illumination with a neat ceiling.

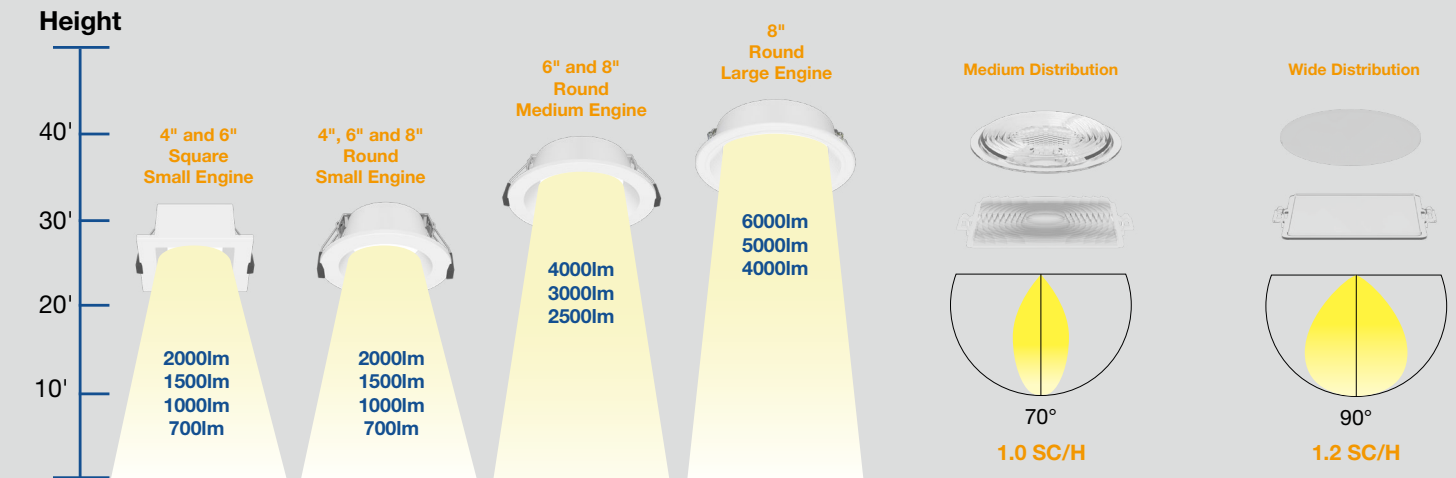

## Various Sizes and Shapes With Abundant Reflector Selections

NYX downlights give architect, lighting designer or contractor an unmatched versatility with a galaxy of reflectors options and finishes. Including full clear, white and black dead front for specific damp or wet location usage, black baffle or white baffle style with white flange for smoother and lower glare light output and the classical clear and white flange for an ageless design. Wall wash kicker options are also available in clear and white, to complement the NYX possibilities, for wall grazing.

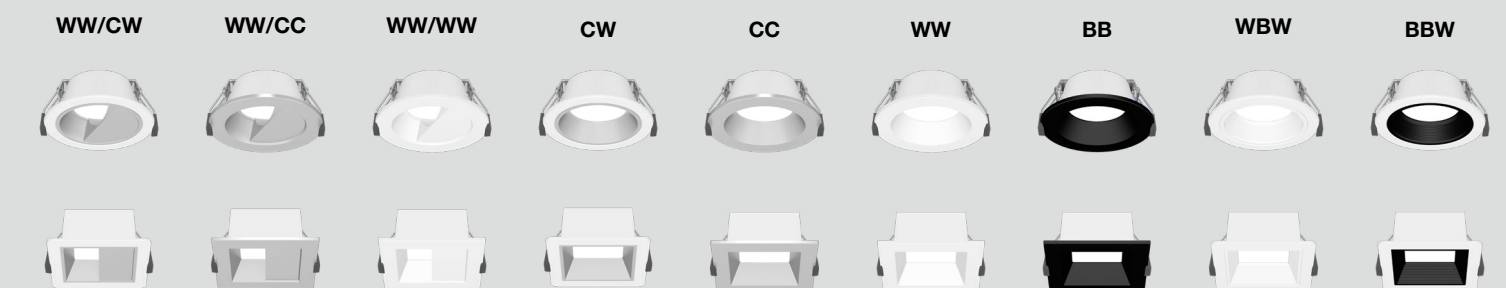

ACCESSORIES		
Product	Model	Description
35126	NCFBFB	Field Installable Butterfly Brackets For New Construction Frame
35125	NCFEMB	Field Installable Emergency Bracket For New Construction Frame
98003	23EMDRIVER	California Title 20 Compliant 23W Emergency LED Driver (Field Installation)
FHUPS1-UNV-25L-SD	FHUPS1-UNV-25L-SD	25W Emergency Micro Inverter for field installation to use with 0-10V Driver options. 100-277VAC (up to 150W with use of 0-10V dimming). CEC Compliant



# SELECTFIT G2 COMMERCIAL DOWNLIGHT



DualDim



## Greater Selection. Better FIT.

SELECTFIT G2 from GREEN CREATIVE brings greater flexibility to your retrofit project or new construction application while maintaining the excellent performance and quality. With a total of 180 field installable SKUs packed in only 6 product SKUs, this new and improved lighting family still offers integrated CCT and lumen output selections. For additional flexibility, the SELECTFIT G2 series now features DualDim technology and a full set of accessories.

### More Integrated CCT and Lumen Options



Get the right amount of light with SELECTFIT still powered by SelectDrive technology. Choose from Low, Medium or High light outputs. With just the flip of switch, ensure that every space has just the right amount of light from 600lm to 4500lm.

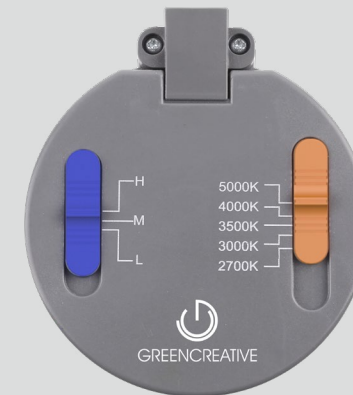

Utilizing our SelectKelvin technology, select the CCT before, during, or after installation with just the flip of a switch. Choose from 2700/3000/3500/4000/5000K CCTs to customize any application and set the right atmosphere for your space.

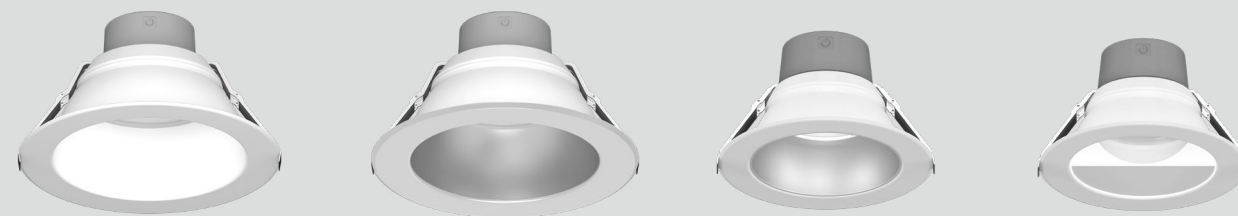
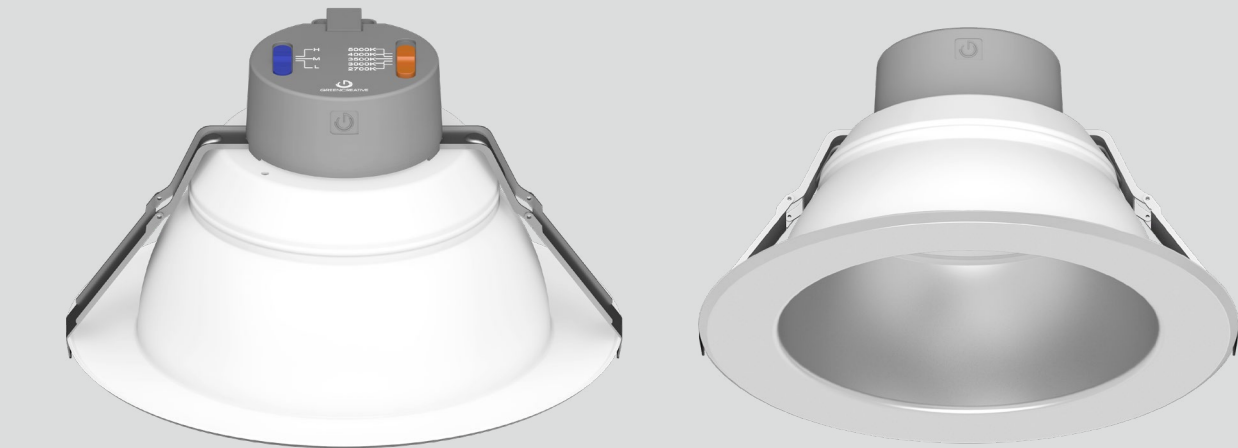

Standard without accessories

With clear-clear flange trim

With flangess clear-white trim

With white wall wash insert

### Ready For Any Dimming Protocol

All SELECTFIT products are suitable for 120-277V input and feature our DualDim technology allowing the luminaire to be dimmed with either 120V TRIAC/ELV or 0-10V controls. Taking the guesswork out of auditing an existing space and providing optimal flexibility while minimizing un-expected installation issues in the field. Whether your project is residential, commercial, mixed-use, new construction or remodel, SELECTFIT will FIT.

# DualDim



### The Same Quality, Durability and Simplicity

SELECTFIT features a die cast heat sink maximizing passive thermal management for high max ambient temperatures. The operating range is -40°F to 113°F (-40°C to 45°C) on all models and IC rating on most models. All models feature Wet location and certified air-tight ratings for maximum adaptability. Proprietary spring action clips enable direct installation in 1/2" to 2" ceiling thicknesses and field accessibility below the ceiling for easy install and service.



### Soothing Pure Light

A smooth and uniform lighting distribution, offered with an LED binning within 3 SDCM maximum, in minimum 90 CRI, with calculated L70 of 100,000hrs+ for impeccable uniformity and incredible color rendering over the life of the SELECTFIT fixture.



## SPECIFICATIONS

Series	Size	CRI	CCT	Dimming
<b>SLFT</b> SELECTFIT Downlight	<b>4</b> 4" 900 / 750 / 600 lumens	<b>9</b> CRI 90+	<b>CCT5S</b> Selectable CCT 2700 / 3000 / 3500 / 4000 / 5000K	<b>DUALDIM</b> 120V-277V, 50/60Hz. 0-10V or Forward/Reverse phase dimming at 120V only.
	<b>6</b> 6" 1,650 / 1,300 / 1,000 lumens			
	<b>6HO</b> 6" 2,900 / 2,300 / 1,750 lumens			
	<b>8</b> 8" 2,100 / 1,600 / 1,200 lumens			
	<b>8HO</b> 8" 4,200 / 3,600 / 2,900 lumens			
	<b>9.5</b> 9.5" 4,000 / 3,200 / 2,400 lumens			

# SELECTFIT G2 COMMERCIAL DOWNLIGHT

## A Solution For Any Ceiling Height

With SELECTFIT you can get the right amount of light for any project. Ranging from 600lm to 4,500lm, SELECTFIT will fill any existing space. The 6" and 8" are now offered in high output versions perfectly suited for high ceilings, such as auditorium, atrium, lobby, mall, theater, cinema, hallway, train station, airport and so on. The long lifetime and superior heat dissipation, on IC or non-IC rating models, will ensure you a maintenance free installation with a fast ROI and exceptionally long lifetime.



## Specify Further With Additional Accessories

SELECTFIT also offers tool-less field-installable accessories to give designers more options. The clear trim insert, wall washer, and medium Fresnel optic allow you to redesign the lighting layout according to the demands of the space. Whether you need to alter a beam angle, highlight artwork on a wall, match existing layout or optimize distribution across your application, the SELECTFIT has an attachment that can help you meet your goals.

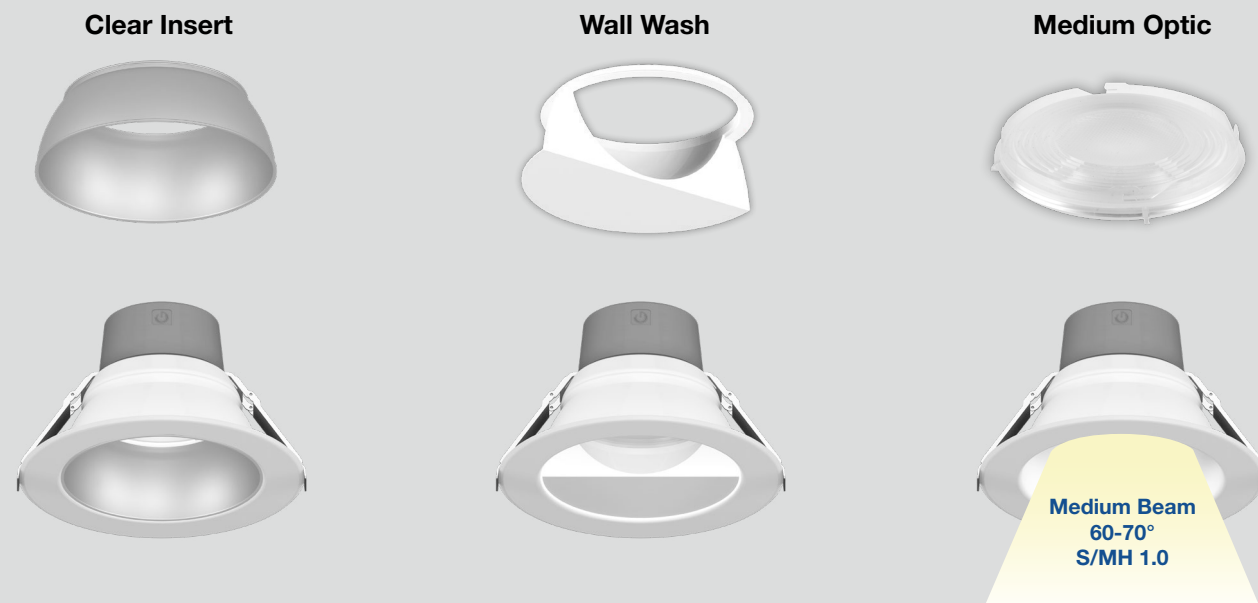

Office spaces, mixed-used spaces, condominium, agencies...



Lobby, auditorium, theater, atrium, schools, university...

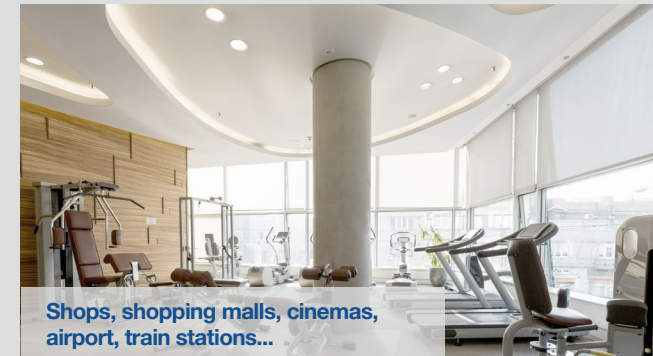

Shops, shopping malls, cinemas, airport, train stations...



Hotel, casinos, restaurant, multi-family, hospitals, clinics...

## ACCESSORIES

Product	Model	Description
37041	SLFT4/CL/TRIM	SELECTFIT G2 4" Field Installable flangeless clear trim insert (Clips inside the reflector for Clear + White flange finish)
37042	SLFT6/CL/TRIM	SELECTFIT G2 6" Field Installable flangeless clear trim insert (Clips inside the reflector for Clear + White flange finish)
37043	SLFT8/CL/TRIM	SELECTFIT G2 8" Field Installable flangeless clear trim insert (Clips inside the reflector for Clear + White flange finish)
35160	SLFT/TRIM9.5/CC	Field installable 9.5" Clear Trim and flange Insert (Attaches on the flange for Clear + Clear flange finish)
37036	SLFT4/MD/OPTIC	SELECTFIT G2 4" Field changeable Medium Optic (need to remove and replace the standard optic)
37037	SLFT6/MD/OPTIC	SELECTFIT G2 6" Field changeable Medium Optic (need to remove and replace the standard optic)
37038	SLFT8/MD/OPTIC	SELECTFIT G2 8" Field changeable Medium Optic (need to remove and replace the standard optic)
37039	SLFT4/WW/ACC	SELECTFIT G2 4" Field installable Wall Wash white insert (wall wash insert can not be combined with Trim insert)
37040	SLFT6/WW/ACC	SELECTFIT G2 6" Field installable Wall Wash white insert (wall wash insert can not be combined with Trim insert)
35121	NCFJB4	4" New Construction Frame for T-Grid ceilings and stud/joist mounting
35122	NCFJB6	6" New Construction Frame for T-Grid ceilings and stud/joist mounting
35123	NCFJB8	8" New Construction Frame for T-Grid ceilings and stud/joist mounting
35124	NCFJB9.5	9.5" New Construction Frame for T-Grid ceilings and stud/joist mounting
35126	NCFBFB	Field Installable Butterfly Brackets For New Construction Frame
35125	NCFEMB	Field Installable Brackets For emergency Driver or Inverter with New Construction Frame
98502	NCPLATE468	4", 6" and 8" New Construction Plate for Stud/Joist Mounting
98501	NCPLATE/T4689	New Construction or Remodel Plate for T-Grid Ceilings
98569	GOOFRING4	4" Goof Ring - Outer Diameter 8-1/8"
98568	GOOFRING6	6" Goof Ring - Outer Diameter 10-1/2"
98567	GOOFRING8	8" Goof Ring - Outer Diameter 12-1/2"
98566	GOOFRING9.5	9.5" Goof Ring - Outer Diameter 14-3/16"
98003	23EMDRIVER	California Title 20 Compliant 23W Emergency LED Driver (Field Installation)
FHUPS1-UNV-25L-SD	FHUPS1-UNV-25L-SD	25W Emergency Micro Inverter for field installation to use with 0-10V Driver options. 100-277VAC (up to 150W with use of 0-10V dimming). CEC Compliant

# INNOFIT PLUS COMMERCIAL DOWNLIGHT



Select Kelvin

Select Drive

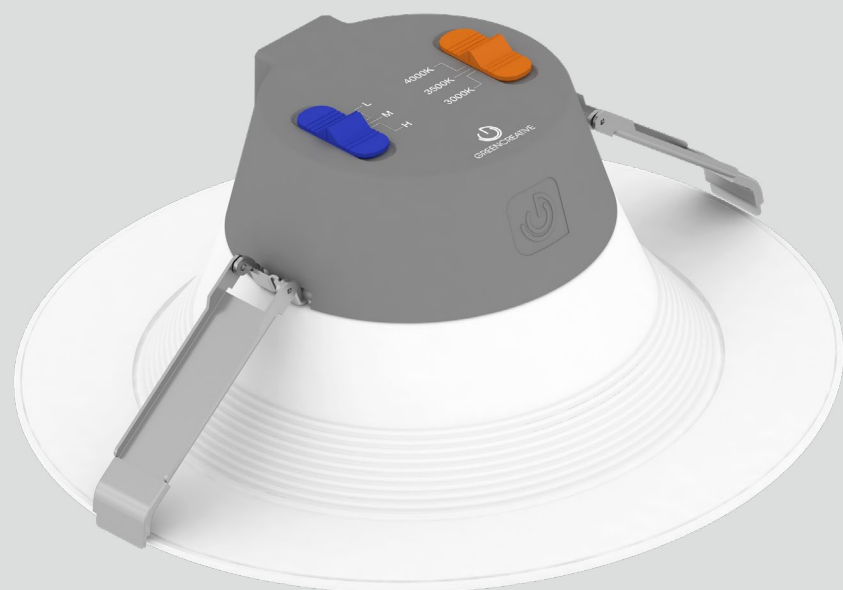

## Unrivalled Efficiency. Upgraded Flexibility.

Powered by SelectDrive and SelectKelvin technologies, this new and improved downlight family offers field-selectable light output and color temperature selection, to accommodate your project's unique requirements and intended atmosphere. These features provide exceptional flexibility for contractors and installers when altering designs on the spot. Distributors also benefit from reduced processing, warehousing and logistics costs, as one product provides nine unique combinations of light output and color.

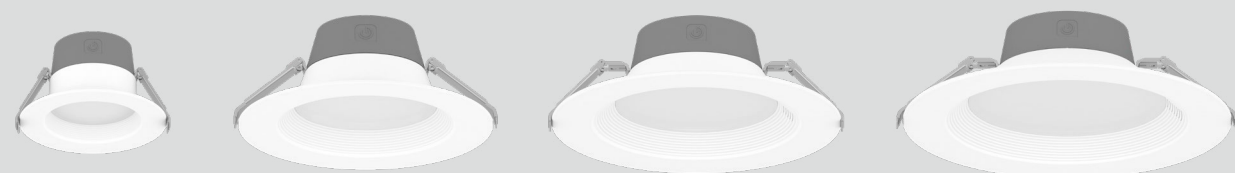

Select Drive

### 3 Lumen Levels

	Low	Med	High
4"	700lm	1050lm	1400lm
6"	1125lm	1625lm	2000lm
8"	1560lm	2080lm	3000lm
9.5"	2000lm	3000lm	3500lm

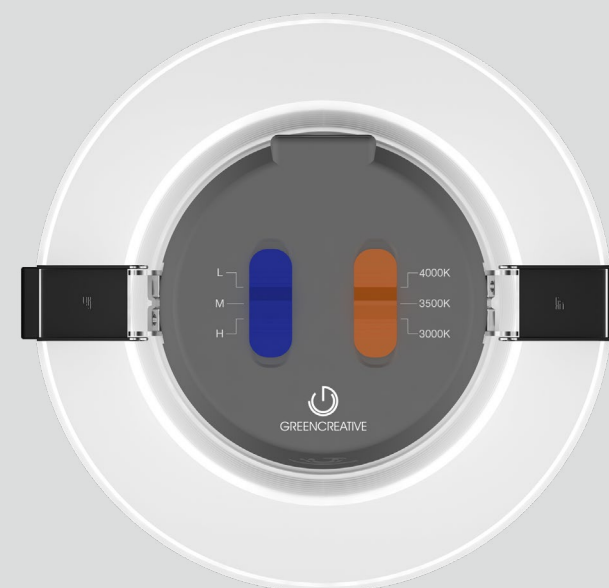

Select Kelvin

### 3 Color Temperatures

- 3000K Warm White
- 3500K Neutral White
- 4000K Cool White

## SPECIFICATIONS

Series	Size	CRI	CCT	Dimming
<b>INFTP</b> INNOFIT PLUS Downlight	<b>4</b> 4" 700 / 1,050 / 1,400lm	<b>8</b> CRI 80+	<b>CCT3S</b> Selectable CCT 3000 / 3500 / 4000K	<b>DIM010UNV</b> 120-277V, 50/60Hz. 0-10V dimming at 120-277V.
	<b>6</b> 6" 1,125 / 1,625 / 2,000lm			<b>DIM120V<sup>1</sup></b> 120V, 60Hz, Forward/Reverse phase dimming at 120V only.
	<b>8</b> 8" 1,560 / 2,080 / 3,000lm			
	<b>9.5</b> 9.5" 2,000 / 3,000 / 3,500lm			

<sup>1</sup> DIM120V only available in 6" and 8"



# INNOFIT PLUS COMMERCIAL DOWNLIGHT

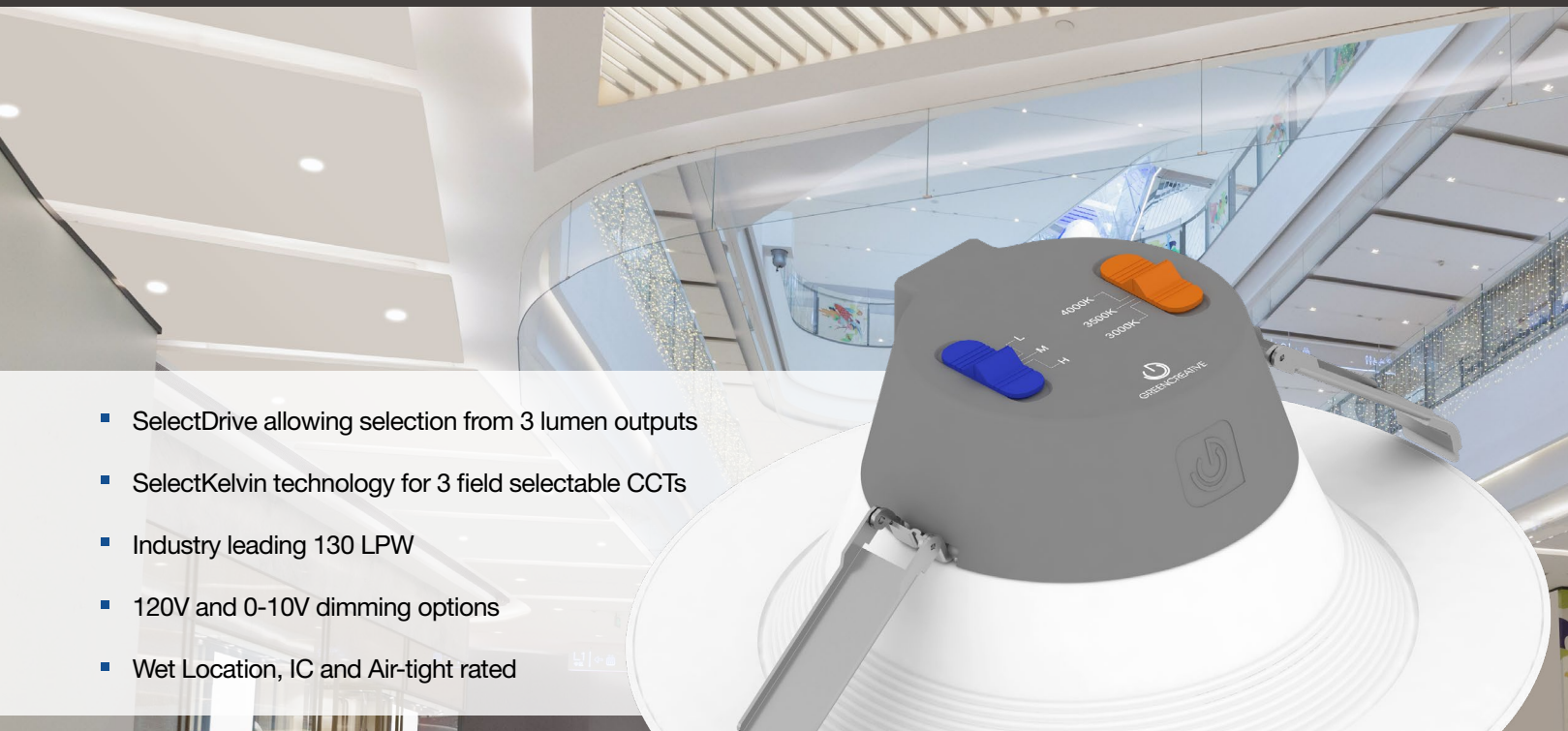

- SelectDrive allowing selection from 3 lumen outputs
- SelectKelvin technology for 3 field selectable CCTs
- Industry leading 130 LPW
- 120V and 0-10V dimming options
- Wet Location, IC and Air-tight rated

## Maximum Energy Savings

The INNOFIT Plus has been engineered for efficiency without sacrificing performance. With an industry-leading efficacy of up to 130 lumens per watt, installing the INNOFIT Plus offers maximum energy savings and results in a swift ROI.

\* Fixed-CCT 6" and 8" 0-10V dimmable models also available. Consult GREEN CREATIVE for more information.



Quick ROI



Energy Savings



Low Labor Costs

## Universal Compatibility

The family is available in 4", 6", 8" and 9.5" sizes with models available for either 0-10V or 120V TRIAC/ELV dimming systems. Field installable emergency back-ups are also available for emergency lighting requirements. Certified with Air-Tight, IC and Wet Location ratings, the INNOFIT Plus is the optimal choice for almost any retrofit application.



0-10V

DIMMABLE



120V

DIMMABLE



WET LOCATION



AIR TIGHT



IC RATED



## INNOFIT G2 Active SKUs

Image	Product	Model	Description
	35068	INFT6/835/DIM010UNV	6" INNOFIT GEN2 Downlight 3500K Selectable power outputs 6.5W / 9W / 13W 120-277V 0-10V Dimmable
	35069	INFT6/840/DIM010UNV	6" INNOFIT GEN2 Downlight 4000K Selectable power outputs 6.5W / 9W / 13W 120-277V 0-10V Dimmable
	35073	INFT8/835/DIM010UNV	8" INNOFIT GEN2 Downlight 3500K Selectable power outputs 8.5W / 12W / 17W 120-277V 0-10V Dimmable
	35074	INFT8/840/DIM010UNV	8" INNOFIT GEN2 Downlight 4000K Selectable power outputs 8.5W / 12W / 17W 120-277V 0-10V Dimmable

## ACCESSORIES

Product	Model	Description
35121	NCFJB4	4" New Construction Frame for T-Grid ceilings and stud/joist mounting
35122	NCFJB6	6" New Construction Frame for T-Grid ceilings and stud/joist mounting
35123	NCFJB8	8" New Construction Frame for T-Grid ceilings and stud/joist mounting
35124	NCFJB9.5	9.5" New Construction Frame for T-Grid ceilings and stud/joist mounting
35126	NCFBFB	Field Installable Butterfly Brackets For New Construction Frame
35125	NCFEMB	Field Installable Brackets For emergency Driver or Inverter with New Construction Frame
98502	NCPLATE468	4", 6" and 8" New Construction Plate for Stud/Joist Mounting
98501	NCPLATE/T4689	New Construction or Remodel Plate for T-Grid Ceilings
98569	GOOFRING4	4" Goof Ring - Outer Diameter 8-1/8"
98568	GOOFRING6	6" Goof Ring - Outer Diameter 10-1/2"
98567	GOOFRING8	8" Goof Ring - Outer Diameter 12-1/2"
98566	GOOFRING9.5	9.5" Goof Ring - Outer Diameter 14-3/16"
98003	23EMDRIVER	California Title 20 Compliant 23W Emergency LED Driver (Field Installation)
FHUPS1-UNV-25L-SD	FHUPS1-UNV-25L-SD	25W Emergency Micro Inverter for field installation to use with 0-10V Driver options. 100-277VAC (up to 150W with use of 0-10V dimming). CEC Compliant



DualDim

Select Kelvin



## Multiple Choices Exceptional Flexibility

The MULTIFIT downlight family offers multiple product choices providing exceptional flexibility for any space

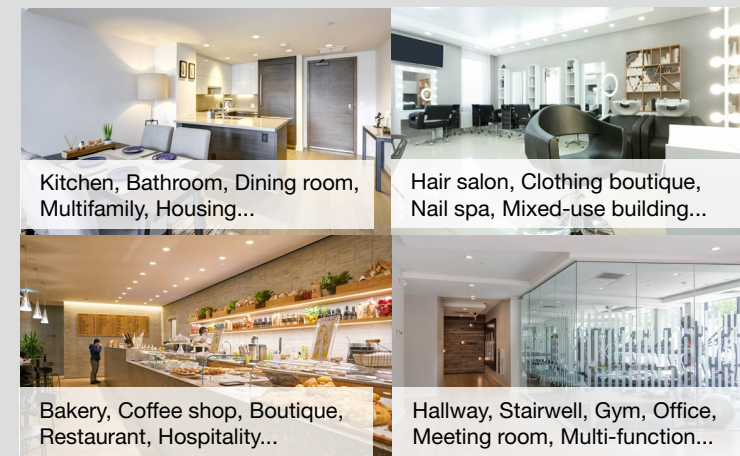

### A Comprehensive Selection Of Fixtures

#### Flat Round Downlight (MFR)

Your classic downlight, with 1/2" baffle for glare control and a familiar style, which makes it suitable for any space.



#### Gimbal Round Downlight (MGR)

An adjustable downlight, for your slope ceiling, wall grazing and highlighting artwork and architectural elements by directing the light where you need it.



#### Cloud Round Downlight (MCR)

Trimless cloud downlight designed to add side lighting for general area lighting.



### Available For Multiple Mounting Heights

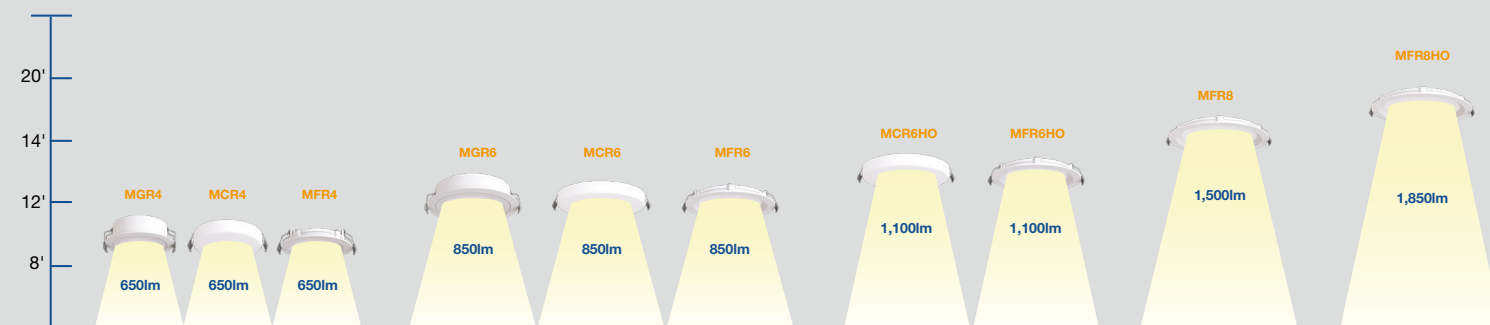

SPECIFICATIONS					
Model Series	Size	CRI	CCT	Driver	Driver Style
<b>MFR</b> MULTIFIT Round Flat	<b>4</b> 4" 600lm	<b>9</b> CRI 90+	<b>CCT5S</b> Selectable CCT 2700/3000/3500/4000/5000K	<b>DUALDIM</b> 120V-277V, 50/60Hz. 0-10V or Forward/Reverse phase dimming at 120V only.	<b>EXT</b> External driver box with quick connector
<b>MCR</b> <sup>1</sup> MULTIFIT Round Cloud	<b>6</b> 6" 800lm				
<b>MGR</b> <sup>2</sup> MULTIFIT Round Gimbal	<b>6HO</b> 6" 1,000				
	<b>8</b> 8" 1,500lm				
	<b>8HO</b> 8" 2,000lm				

### The Right CCT For Your Project

Utilizing our SelectKelvin technology, select the CCT before, during, or after installation with just the flip of a switch. The external switch allows you set the color temperature to 2700/3000/3500/4000/5000K CCT during or even after installation to customize any application and set the right atmosphere for your space.

### Ready For Any Dimming Protocol

All MULTIFIT products are suitable for 120-277V input and feature our DualDim technology allowing the luminaire to be dimmed with either TRIAC/ELV or 0-10V controls. Taking the guesswork out of auditing an existing space and providing optimal flexibility while minimizing un-expected installation issues in the field. Whether your project is residential, commercial, mixed-use, new construction or remodel, MULTIFIT allows you to use one luminaire and simplify all phases of the job from specification to ordering to installation!

### Installation Made Easy

MULTIFIT fixtures install directly into the ceiling without the need for an additional J-box or recessed can. All you need is a hole in the ceiling, wire the driver and use the springs action clips to sit the fixture flush and secured in no-time.



The shallow design, along with its IC, Air-tight and Wet Location ratings, allow any MULTIFIT to install virtually anywhere.



DualDim



<sup>1</sup> Round Cloud downlight is available in 4" 600lm, 6" 800lm, and 6" HO 1000lm only. <sup>2</sup> Round Gimbal downlight is available in 4" 600lm and 6" 800lm only.



## Adjustable Fixture Aiming

Get the right light in the right place with the MINIFIT gimbals. The gimbals come with a 38° beam acrylic optic, producing a consistent, precise beam of light. In addition, they rotate 360° and tilt up to 30° so you can mount them in any orientation in the ceiling and still aim the light to graze textured walls, highlight artwork, or emphasize architectural features. Perfect for residential, retail and hospitality applications.

## Quick and Easy Installation

The MINIFIT family is quick and easy to install. Connecting power in the external junction box is a breeze with the push in connectors. Wiring the fixture is even easier with the plenum rated quick connector. The optional new construction plates, keyhole mounting slots and spring clip hooks allow for a simple installation and compliance with local building codes. The sturdy spring action clips will keep the fixture tight to the ceiling, ensuring an aesthetically pleasing installation.

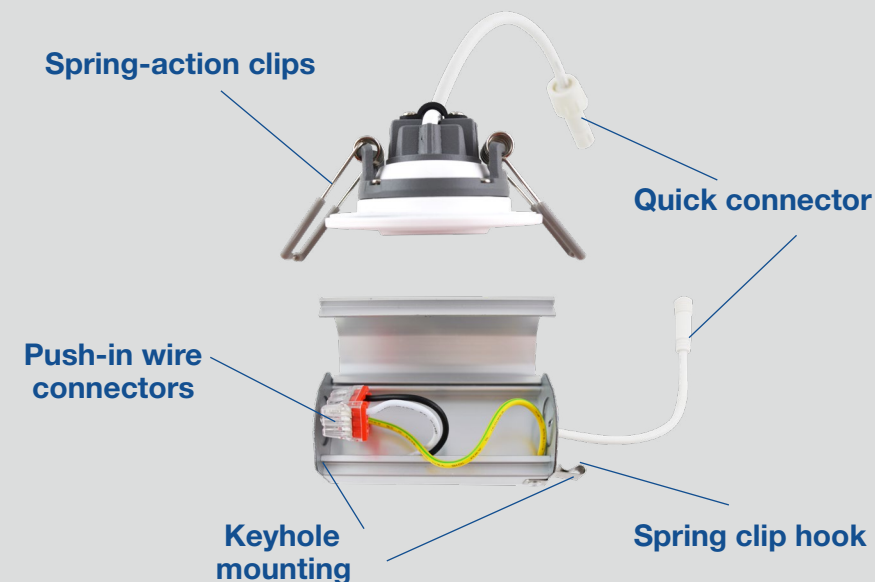

## SPECIFICATIONS

Product	Model	CCT	Lumens	CRI (typ.)	LPW	Dim	Equiv.	Beam Angle	Life (hrs)	Voltage	ES / JA8
98439	GIMB1/927/FL/DIM120	2700K	320	90	64	120V		38°	50,000	120V	N.A. / ✓
98440	GIMB1/930/FL/DIM120	3000K	350	90	70	120V	35W	38°	50,000	120V	✓ / ✓
98441	GIMB1/940/FL/DIM120	4000K	390	90	78	120V		38°	50,000	120V	✓ / ✓
98442	GIMB2/927/FL/DIM120	2700K	680	90	73	120V		38°	50,000	120V	✓ / ✓
98443	GIMB2/930/FL/DIM120	3000K	720	90	75	120V	50W	38°	50,000	120V	✓ / ✓
98444	GIMB2/940/FL/DIM120	4000K	750	90	78	120V		38°	50,000	120V	✓ / ✓

## ACCESSORIES

Product	Model	Description
98584	GIMB1NCPLATE	Gimbal 1" New Construction Plate for Stud / Joist mounting
98585	GIMB2NCPLATE	Gimbal 2" New Construction Plate for Stud / Joist mounting
35097	GIMBCON6	MINIFIT Gimbal 6 foot extension cable
35098	GIMBCON20	MINIFIT Gimbal 20 foot extension cable
98003	23EMDRIVER	California Title 20 Compliant 23W Emergency LED Driver

# 2" MINIFIT MODULE DOWNLIGHT



## Extensive Trim Selection

The 2" MINIFIT modules have a variety of field interchangeable trim options to compliment many different applications. The matte white deep trim gimbal tilts up to 45° and accommodates an open reflector, pinhole reflector or a wall wash optic, so you can place the light exactly where desired. The flat trim gimbal also tilts up to 45° and comes in matte white or brushed metal finishes to accommodate many ceiling decors. The IP65 rated flat glass trims allow for highlighting architectural features in the most demanding wet locations. The depth and breadth of the trim options is sure to accommodate many lighting project needs.

## SPECIFICATIONS

Product	Model	CCT	Lumens	CRI (typ.)	LPW	Dim	Equiv.	Beam Angle	Life (hrs)	Voltage	ES / JA8
98571	MM2/927/FL/DIM120	2700K	720	90	90	120V	50W	38°	50,000	120V	✓/✓
98572	MM2/930/FL/DIM120	3000K	750	90	94	120V		38°	50,000	120V	✓/✓
98573	MM2/940/FL/DIM120	4000K	780	90	98	120V		38°	50,000	120V	✓/✓
98574	MM2/950/FL/DIM120	5000K	780	90	98	120V		38°	50,000	120V	✓/✓
98575	MM2T/RFT/OP/WH	MM2 Trim Round Flat - Open White									
98576	MM2T/RFT/OP/BM	MM2 Trim Round Flat - Open Brushed Metal									
98577	MM2T/RFT/GL/WH	MM2 Trim Round Flat - Glass Cover White									
98578	MM2T/RFT/GL/BM	MM2 Trim Round Flat - Glass Cover Brushed Metal									
98579	MM2T/RDT/OP/WH	MM2 Trim Round Deep - Open White									
98580	MM2T/RDT/PN/WH	MM2 Trim Round Deep - Pinhole White									
98581	MM2T/RDT/WW/WH	MM2 Trim Round Deep - Wall Wash White									

## Quick and Easy Installation

Installing the 2" MINIFIT modules is very simple. Attach the driver box to either the ceiling joist or optional MM2NCPLATE new construction plate. Connect the incoming power via the push in connectors and then attach the module with the quick connect plenum rated cord. Click the module into the desired trim and use the spring clips to snap the module into the ceiling for a clean, modern look.

Spring-action clips

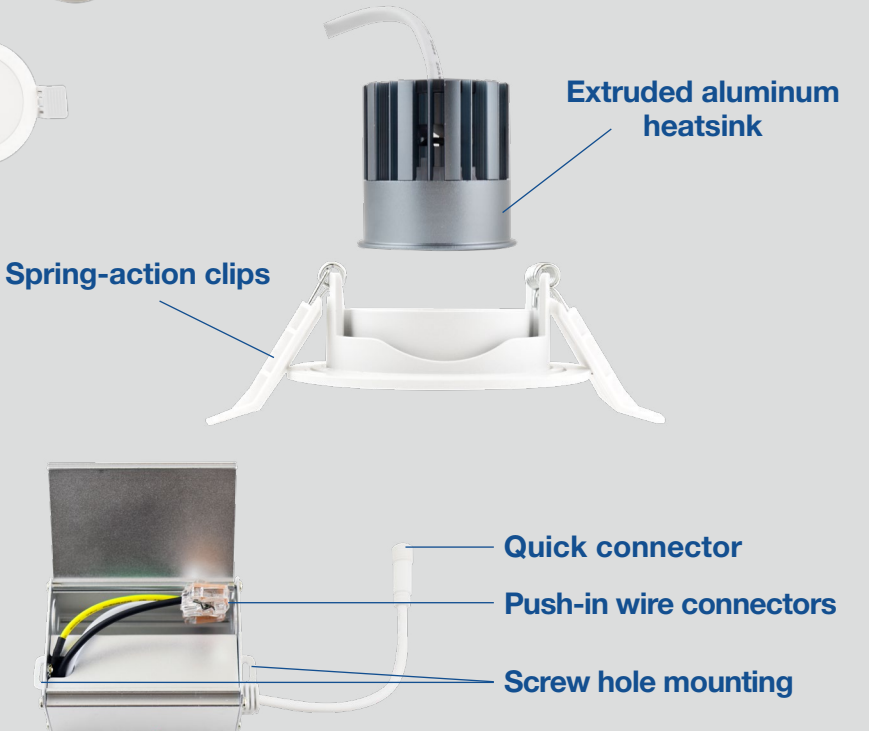

Extruded aluminum heatsink

Quick connector

Push-in wire connectors

Screw hole mounting

## ACCESSORIES

Product	Model	Description
98589	MM2NCPLATE	MINIFIT 2" Module New Construction Plate for Stud / Joist mounting
35095	MM2CON6	MINIFIT 2" Module 6 foot extension cable
35096	MM2CON20	MINIFIT 2" Module 20 foot extension cable
98003	23EMDRIVER	California Title 20 Compliant 23W Emergency LED Driver

# THINFIT EXT DOWNLIGHT

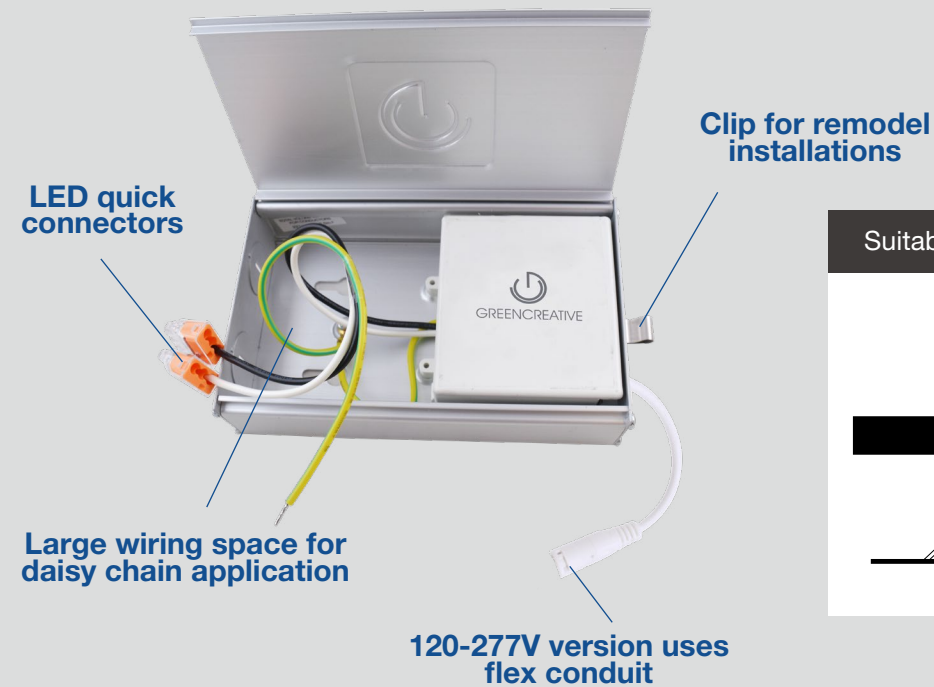

Suitable for Shallow Ceiling Applications

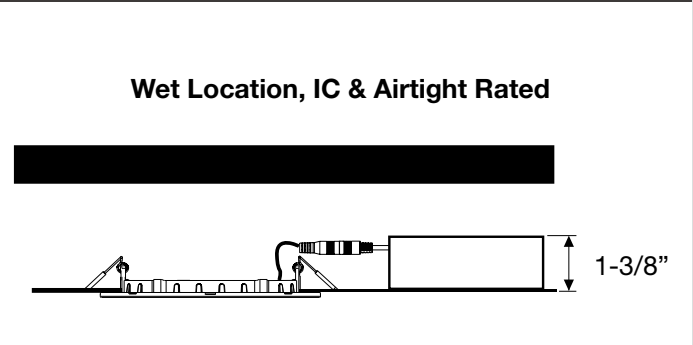

Installs Directly into Ceiling - No Housing Needed

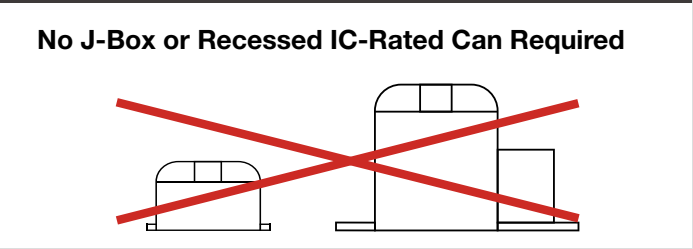

- For new construction or remodel installation
- Innovative design saves time & materials
- Easy to use spring-action clips
- 120V Forward phase (TRIAC) / Reverse phase (ELV) or 0-10V Dimmable

## SPECIFICATIONS

Product	Model	CCT	Lumens	CRI (typ.)	LPW	Dim	Equiv.	Beam Angle	Life (hrs)	Voltage	Wet	ES / JA8
98104	10NCDLR4DIM/927/EXT	2700K	720	90	70	120V	65W	110°	50,000	120V	Yes	✓/✓
98105	10NCDLR4DIM/930/EXT	3000K	720	90	72	120V	65W	110°	50,000	120V	Yes	✓/✓
98106	10NCDLR4DIM/940/EXT	4000K	740	90	74	120V	65W	110°	50,000	120V	Yes	✓/✓
98215	10NCDLR4DIM/935/277V/EXT	3500K	720	90	72	0-10V	65W	110°	50,000	120-277V	Yes	✓/✓
98216	10NCDLR4DIM/940/277V/EXT	4000K	740	90	74	0-10V	65W	110°	50,000	120-277V	Yes	✓/✓
98108	12NCDLR6DIM/930/EXT	3000K	920	90	77	120V	85W	110°	50,000	120V	Yes	✓/✓
98109	12NCDLR6DIM/940/EXT	4000K	940	90	78	120V	85W	110°	50,000	120V	Yes	✓/✓
98217	12NCDLR6DIM/930/277V/EXT	3000K	920	90	77	0-10V	85W	110°	50,000	120-277V	Yes	✓/✓
98218	12NCDLR6DIM/935/277V/EXT	3500K	920	90	77	0-10V	85W	110°	50,000	120-277V	Yes	✓/✓
98219	12NCDLR6DIM/940/277V/EXT	4000K	940	90	78	0-10V	85W	110°	50,000	120-277V	Yes	✓/✓
98110	24.5NCDLR8DIM/927/EXT	2700K	1,820	90	74	120V	125W	110°	50,000	120V	Yes	✓/✓
98111	24.5NCDLR8DIM/930/EXT	3000K	1,920	90	78	120V	125W	110°	50,000	120V	Yes	✓/✓
98220	24.5NCDLR8DIM/930/277V/EXT	3000K	1,920	90	78	0-10V	125W	110°	50,000	120-277V	Yes	✓/✓
98221	24.5NCDLR8DIM/935/277V/EXT	3500K	1,920	90	78	0-10V	125W	110°	50,000	120-277V	Yes	✓/✓

## ACCESSORIES

Product	Model	Description
97847	DLNC4GOOF/R	4" Goof Ring - Outer Diameter 6"
97848	DLNC6GOOF/R	6" Goof Ring - Outer Diameter 8-1/2"
98238	DLNC8GOOF	8" Goof Ring - Outer Diameter 10-1/4"
98501	NCPLATE/T4689	New Construction or Remodel Plate for T-Grid ceilings for use with 4" and 6" models
98502	NCPLATE468	New Construction Plate for Stud/Joist mounting for use with 4", 6" and 8" models
98583	NCPLATEJB	Additional J-Box for new construction plate installation
58012	35EMINVERTER	35W Emergency Inverter for use with 4", 6" and 8" models
58013	35EMINVERTER/CEC	California Title 20 Compliant 35W Emergency Inverter for use with 4", 6" and 8" models
98003	23EMDRIVER	California Title 20 Compliant 23W Emergency LED Driver for use with 4", 6" and 8" models



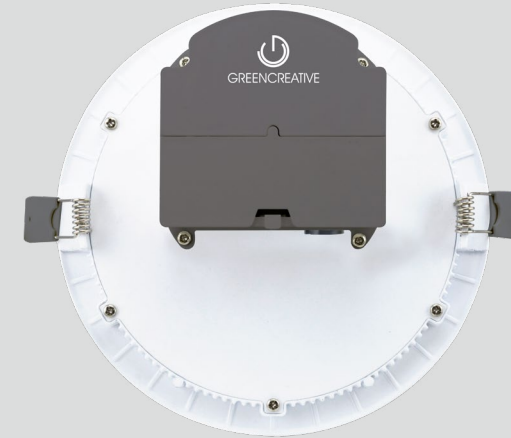
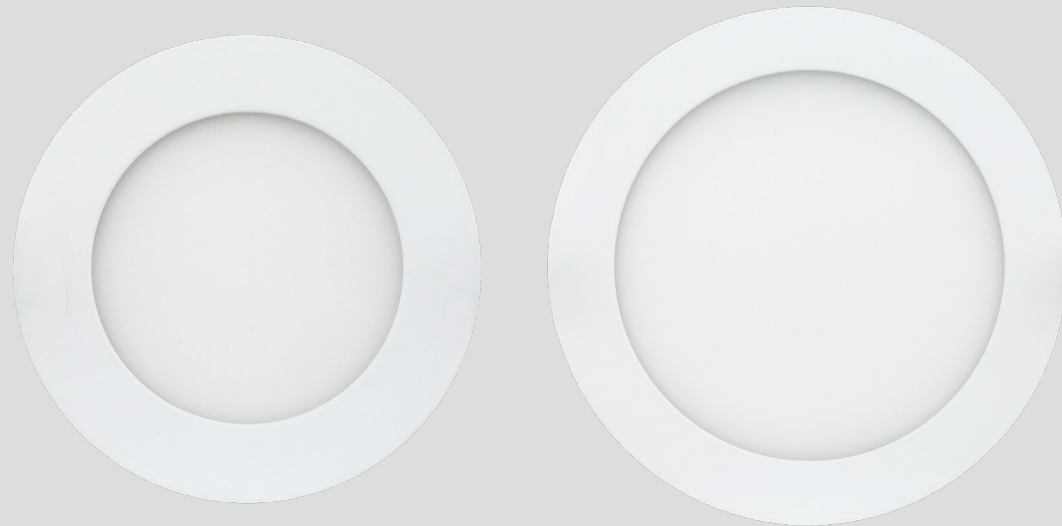

### Edge Lighting Technology

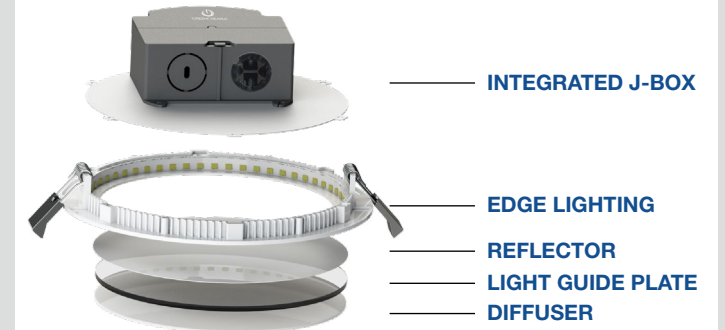

### Installs Directly into Ceiling - No Housing Needed

#### No J-Box or Recessed IC-Rated Can Required

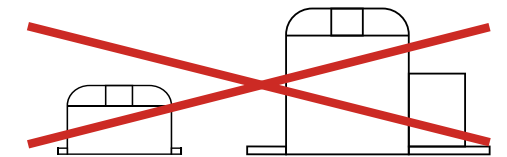

- For new construction or remodel installation
- Innovative design saves time & materials
- Easy to use spring-action clips
- Goof Rings available

### SPECIFICATIONS

Product	Model	CCT	Lumens	CRI (typ.)	LPW	Dim	Equiv.	Beam Angle	Life (hrs)	Voltage	Wet	ES
58025	8.5DLNC4DIM/827	2700K	510	82	60	120V	50W	100°	40,000	120V	No	✓
58028	11.6DLNC6DIM/827	2700K	810	82	70	120V	75W	100°	40,000	120V	No	✓
58030	11.6DLNC6DIM/840	4000K	850	82	73	120V	75W	100°	40,000	120V	No	✓

### ACCESSORIES

Product	Model	Description
97847	DLNC4GOOF/R	4" Goof Ring - Outer Diameter 6"
97848	DLNC6GOOF/R	6" Goof Ring - Outer Diameter 8-1/2"
98501	NCPLATE/T4689	New Construction or Remodel Plate for T-Grid ceilings for use with 4" and 6" models
98502	NCPLATE468	New Construction Plate for Stud/Joist mounting for use with 4" and 6" models
98583	NCPLATEJB	Additional J-Box for new construction plate installation
58012	35EMINVERTER	35W Emergency Inverter for use with 4" and 6" models
98003	23EMDRIVER	California Title 20 Compliant 23W Emergency LED Driver for use with 4" and 6" models

# 3N1 SURFACE MOUNT DOWNLIGHT



Select Kelvin

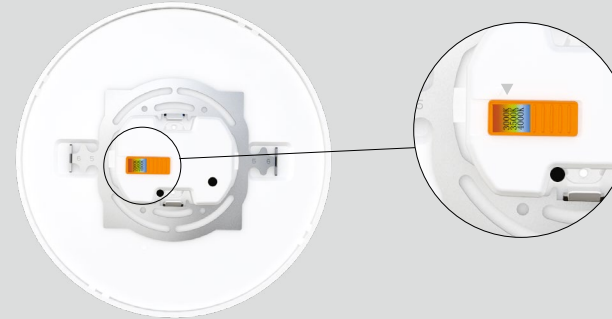
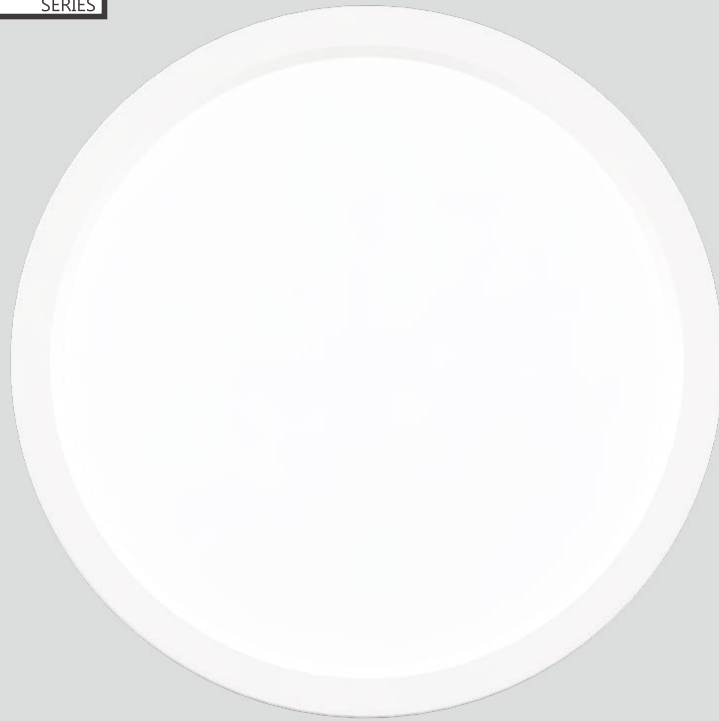

## 3 COLOR TEMPERATURES - 1 PRODUCT

Make your new construction, retrofit or remodel projects easier with the 3N1 downlight family of fixtures, featuring SelectKelvin Technology. Select the CCT before, during or after installation with just the flip of a switch and never worry about having the correct CCT for a project again.

4" J-BOX FLUSHMOUNT

4" / 5-6" CAN RECESSED

SPRING J-BOX FLUSHMOUNT

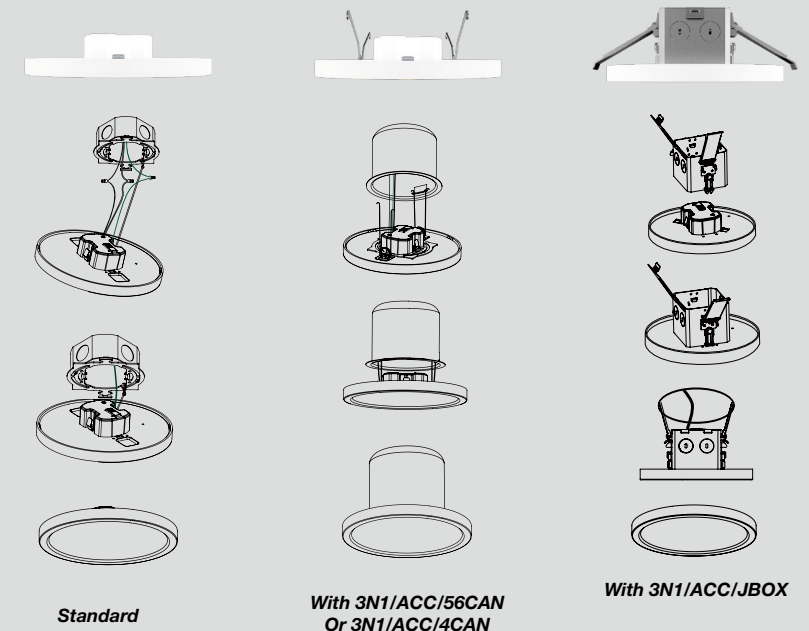

## 3 INSTALLATION METHODS - 1 PRODUCT

The 3N1 5", 7", 9" and 12" all come standard with a surface mount bracket compatible with most 4" J-Box (provided by others).

In addition, the 5" 3N1 retrofits 4" recessed housings and the 7" and 9" 3N1 retrofit 5" and 6" recessed housings, with optional can retrofit accessories (sold separately).

The 5", 7" and 9" 3N1 downlights, can also be used for remodel or new construction by direct mounting to the ceiling with the j-box accessory (sold separately).

## SPECIFICATIONS

Series	Size	CRI	CCT	Dimming
<b>3N1</b> 3 IN 1 Downlight	<b>5</b> 5" 700 lumens	<b>9</b> CRI 90	<b>CCTS</b> Selectable CCT 3000K / 3500K / 4000K	<b>DIM010UNV</b> 120-277V, 0-10V dimming
	<b>7</b> 7" 1,000 lumens			
	<b>9</b> 9" 1,200 lumens			
	<b>12</b> 12" 1,800 lumens			
				<b>DIM120V</b> 120V Line voltage dimming

## ACCESSORIES

Product	Model	Description
35469	3N1/TRM/5/BL	5" 3N1 - Black Trim
35470	3N1/TRM/5/BZ	5" 3N1 - Bronze Trim
35472	3N1/TRM/7/BL	7" 3N1 - Black Trim
35473	3N1/TRM/7/BZ	7" 3N1 - Bronze Trim
35474	3N1/TRM/7/BN	7" 3N1 - Brushed Nickel Trim
35475	3N1/TRM/9/BL	9" 3N1 - Black Trim
35476	3N1/TRM/9/BZ	9" 3N1 - Bronze Trim
35477	3N1/TRM/9/BN	9" 3N1 - Brushed Nickel Trim
35478	3N1/ACC/4CAN	3N1 - 4" Can Retrofit Accessory (for use with 5" 3N1 )
35479	3N1/ACC/56CAN	3N1 - 5/6" Can Retrofit Accessory (for use with 7" and 9" 3N1 )
35480	3N1/ACC/JBOX	Direct Mount Accessory J-Box <sup>1</sup>
98003	23EMDRIVER	California Title 20 Compliant 23W Emergency LED Driver (Field Installation)

Field Selectable CCT with SelectKelvin Technology

Gasketed to provide Air-Tight and Wet Location Ratings



120V Forward and Reverse Phase or 120-277V 0-10V dimming options



Edge lighting technology featuring a PMMA light guide plate

<1" thickness from below the ceiling

90 CRI with 3-steps SDCM binning LEDs

Smooth polycarbonate lens for even light emitting surface with 110° beam angle.

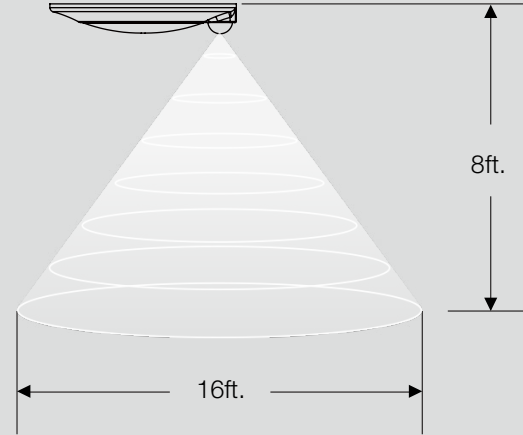

**Integrated PIR Sensor**

The CLICK features a fixture integrated PIR motion sensor. The PIR coverage area is a 16' radius from a standard 8' mounting height. The fixture will turn on during occupancy detection and remain on for 10 minutes after vacancy is detected. Ideal, for laundry rooms, utility rooms, garages, storage rooms, closets or hallways.

**Quick and Easy Installation**

The CLICK with PIR sensor installs in industry standard 4" J-Boxes. Connect the incoming power to the back of the fixture. Remove the fixture lens and screw the fixture to the J-Box with the provided hardware. Reattach the lens and you are good to go with your new sensor integrated, surface mount CLICK.

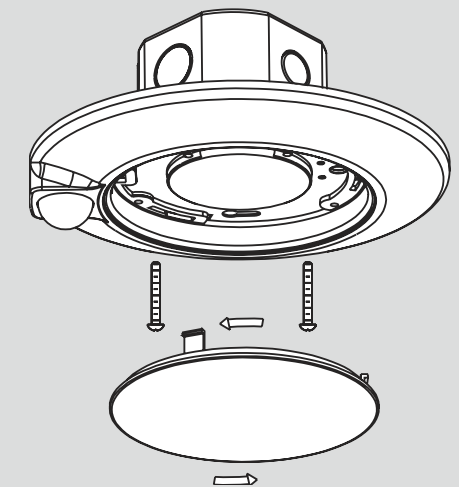

SPECIFICATIONS												
Product	Model	CCT	Lumens	CRI (typ.)	LPW	Dim	Equiv.	Beam Angle	Life (hrs)	Voltage	Wet	ES / JA8
98498	CLKSEN6/10MIN/927/120V	2700K	600	90	60	120V	50W	100°	50,000	120V	Yes	✓/✓
98499	CLKSEN6/10MIN/930/120V	3000K	600	90	60	120V	50W	100°	50,000	120V	Yes	✓/✓
98500	CLKSEN6/10MIN/940/120V	4000K	620	90	62	120V	50W	100°	50,000	120V	Yes	✓/✓

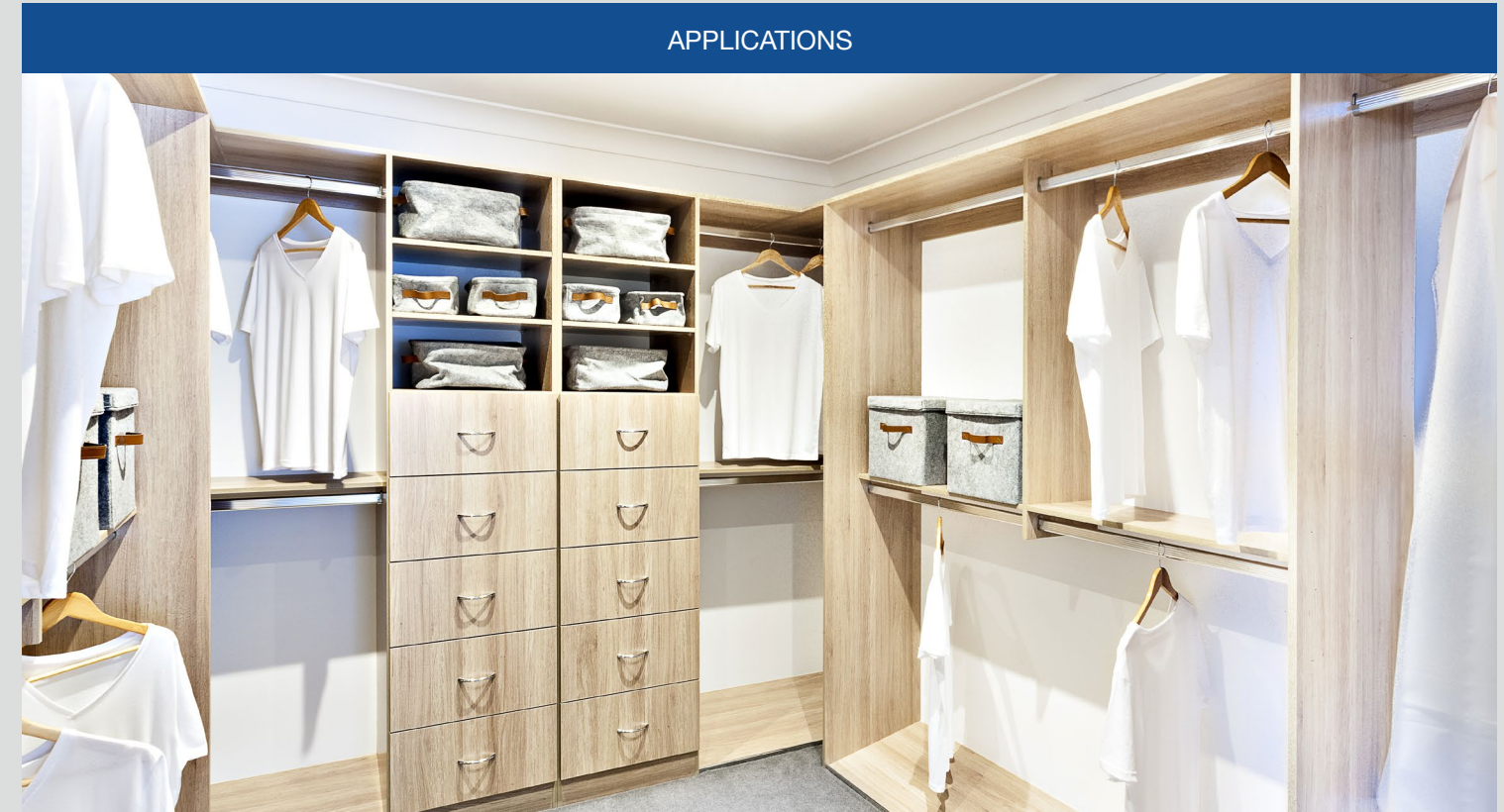

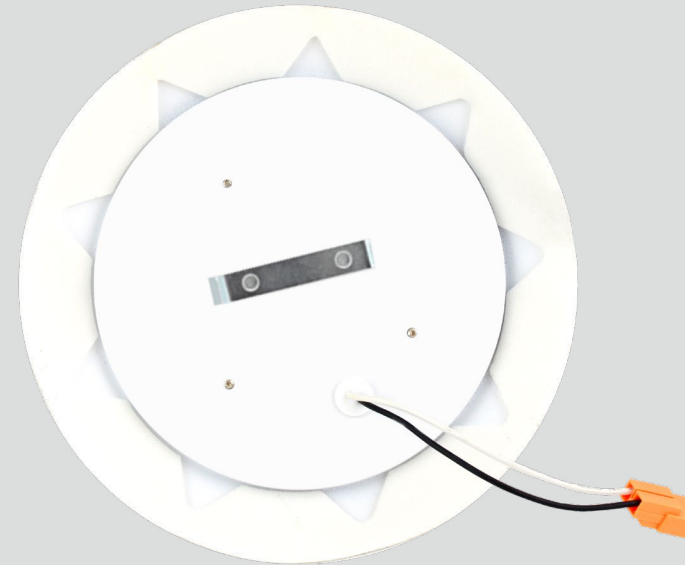
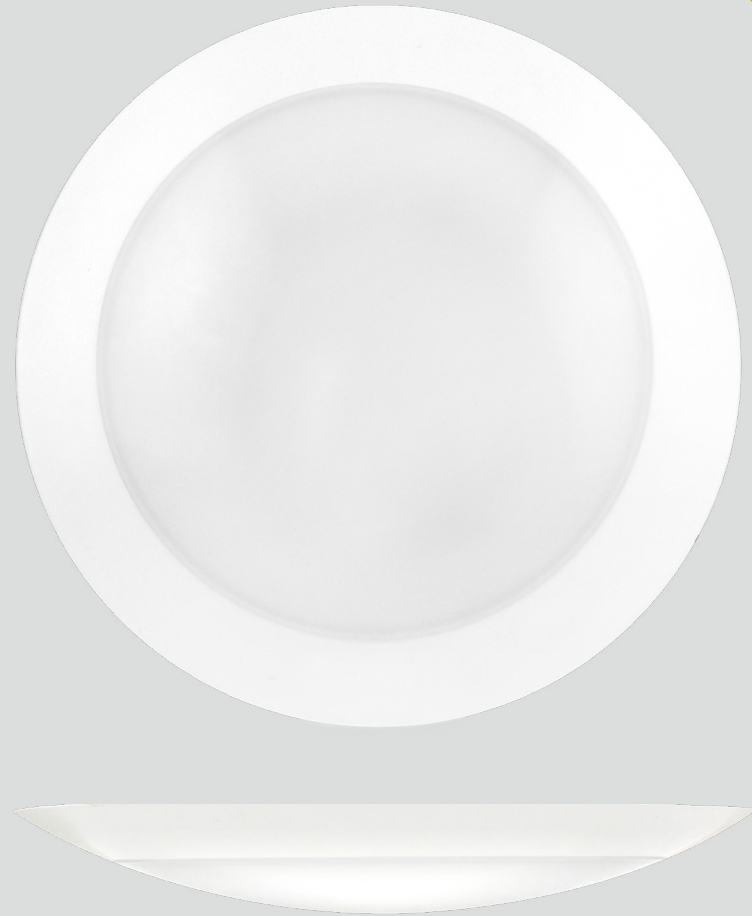

## Seamless Installation



## CLICK 6" 14.5W & 11W - High CRI

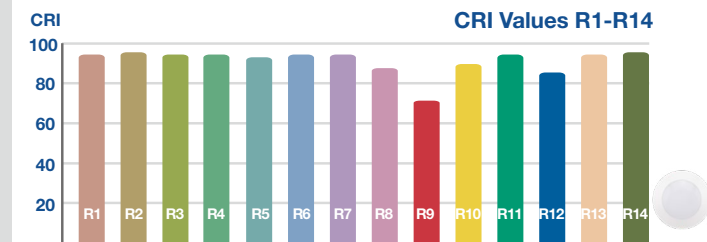

- Innovative CLICK design
- Compatible with 4" J-Boxes (standard)
- 4" & 5-6" recessed can accessories sold separately
- Installs in just minutes - No rewiring

## SPECIFICATIONS

Product	Model	CCT	Lumens	CRI (typ.)	LPW	Dim	Equiv.	Beam Angle	Life (hrs)	Voltage	Wet	ES / JA8
34966	CLK6/927/DIM120V	2700K	792	90	72	120V	65W	110°	50,000	120V	Yes	✓/✓
34967	CLK6/930/DIM120V	3000K	825	90	75	120V	65W	110°	50,000	120V	Yes	✓/✓
34968	CLK6/940/DIM120V	4000K	902	90	82	120V	65W	110°	50,000	120V	Yes	✓/✓
34963	CLK6HO/927/DIM120V	2700K	1,080	90	72	120V	85W	110°	50,000	120V	Yes	✓/✓
34964	CLK6HO/930/DIM120V	3000K	1,125	90	75	120V	85W	110°	50,000	120V	Yes	✓/✓
34965	CLK6HO/940/DIM120V	4000K	1,230	90	82	120V	85W	110°	50,000	120V	Yes	✓/✓

57973 SMDL4/ACC 4" Recessed can accessories

57974 SMDL6/ACC 5-6" Recessed can accessories

## INSTALLATION GUIDE

### 4" J-BOX

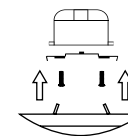

- Attach mounting bracket to J-Box
- Click downlight into mounting bracket

ACCESSORIES INCLUDED:

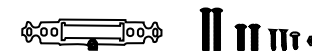

Mounting Bracket J-Box Screws



Wire Nuts LED Adapter

### 4" CAN

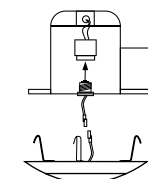

- Connect E26 adapter to the LED adapter
- Insert mounting clips and push downlight up until flush with ceiling

ACCESSORIES SOLD SEPARATELY:



E26 Adapter LED Adapter



Mounting Bracket Mounting Clips

### 5-6" CAN

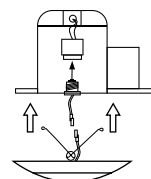

- Connect E26 adapter to the LED adapter
- Squeeze mounting springs and push downlight up until flush with ceiling

ACCESSORIES SOLD SEPARATELY:



E26 Adapter LED Adapter

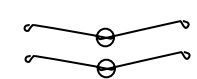

Mounting Springs

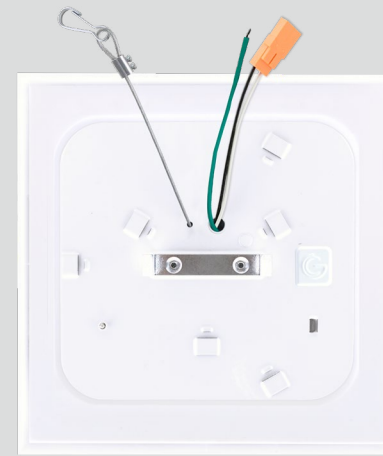
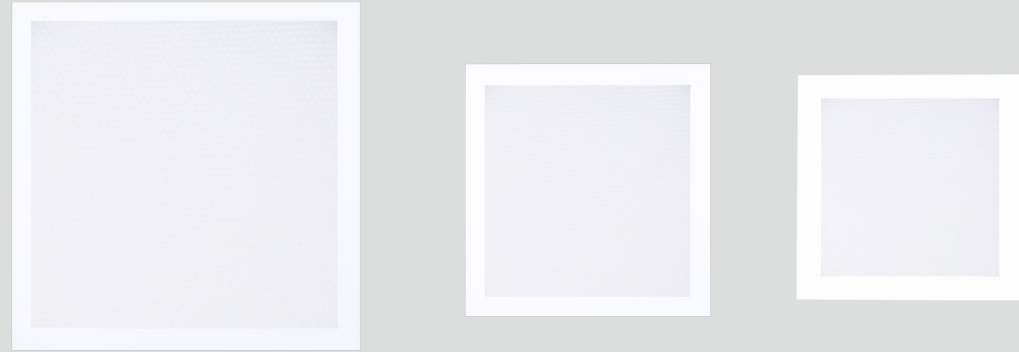

- Innovative CLICK design - Edge lighting technology
- Wet Location & high CRI
- Compatible with 4" J-Boxes (standard)
- 120V Forward phase (TRIAC) / Reverse phase (ELV) or 0-10V Dimmable

### SootheOptic Low Glare Technology

#### Viewing Angle



0°

45°

>65°

SootheOptic low glare technology reduces visual glare and creates a comfortable lighting environment

### SPECIFICATIONS

Product	Model	CCT	Lumens	CRI (typ.)	LPW	Dim	Equiv.	Beam Angle	Life (hrs)	Voltage	Wet	ES / JA8
58247	10SMPS5.5DIM/927	2700K	550	90	55	120V	50W	100°	50,000	120V	Yes	✓ / N.A.
58248	10SMPS5.5DIM/930	3000K	550	90	55	120V	50W	100°	50,000	120V	Yes	✓ / N.A.
58249	10SMPS5.5DIM/940	4000K	560	90	56	120V	50W	100°	50,000	120V	Yes	✓ / N.A.
58244	15SMPS7DIM/927	2700K	850	90	57	120V	75W	100°	50,000	120V	Yes	✓ / N.A.
58245	15SMPS7DIM/930	3000K	850	90	57	120V	75W	100°	50,000	120V	Yes	✓ / N.A.
97975	15SMPS7DIM/927/R	2700K	850	90	57	120V	75W	100°	50,000	120V	Yes	✓ / ✓
97976	15SMPS7DIM/930/R	3000K	850	90	57	120V	75W	100°	50,000	120V	Yes	✓ / ✓
58253	15SMPS7DIM/940/277V	4000K	850	90	58	0-10V	75W	100°	50,000	120-277V	Yes	✓ / N.A.
58242	20SMPS9DIM/930	3000K	1,200	90	60	120V	100W	100°	50,000	120V	Yes	✓ / N.A.
58250	20SMPS9DIM/930/277V	3000K	1,200	90	60	0-10V	100W	100°	50,000	120-277V	Yes	✓ / N.A.
58033	SMP/ACC	4" & 6" Recessed can accessories for 5.5" & 7" Round & Square (5.5" for use in 4" can only, 7" for use in 4" or 6" can)										
98003	23EMDRIVER	California Title 20 Compliant 23W Emergency LED Driver for use with 5.5", 7" and 9" models										



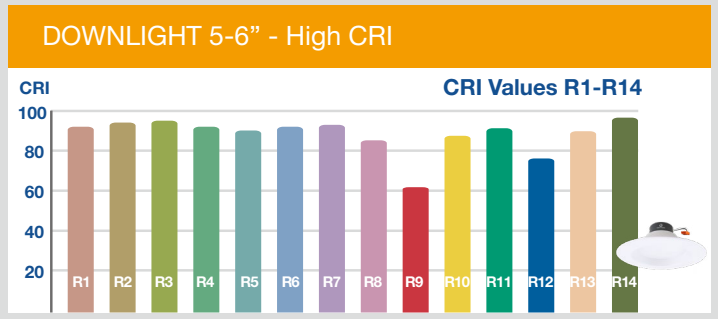
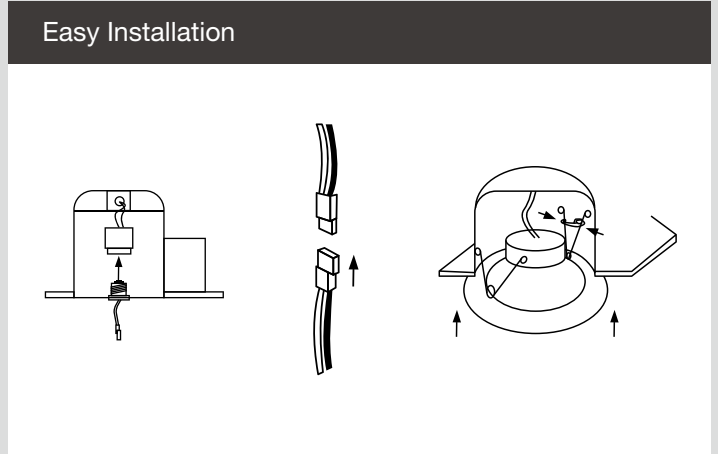

- Compatible with 4" and 5-6" housings
- Installs in just minutes - No rewiring
- High output, up to 1,260 lumens
- High CRI versions rated for Wet Locations

## SPECIFICATIONS

Product	Model	CCT	Lumens	CRI (typ.)	LPW	Dim	Equiv.	Beam Angle	Life (hrs)	Voltage	ES / JA8
97988	10DL4DIM/927	2700K	700	90	70	120V		100°	50,000	120V	✓/✓
97989	10DL4DIM/930	3000K	700	90	70	120V	65W	100°	50,000	120V	✓/✓
97990	10DL4DIM/940	4000K	700	90	70	120V		100°	50,000	120V	✓/✓
97991	12DL6DIM/927	2700K	840	90	70	120V	75W	100°	50,000	120V	✓/✓
97992	12DL6DIM/930	3000K	840	90	70	120V		100°	50,000	120V	✓/✓
97994	18DL6DIM/927	2700K	1,260	90	70	120V	100W	100°	50,000	120V	✓/✓
97995	18DL6DIM/930	3000K	1,260	90	70	120V		100°	50,000	120V	✓/✓
98003	23EMDRIVER	California Title 20 Compliant 23W Emergency LED Driver for use with 4" and 6" models									

## APPLICATIONS



# NOVA WALL WASH TRACK LIGHT

# NOVA

Select Drive

Select Kelvin

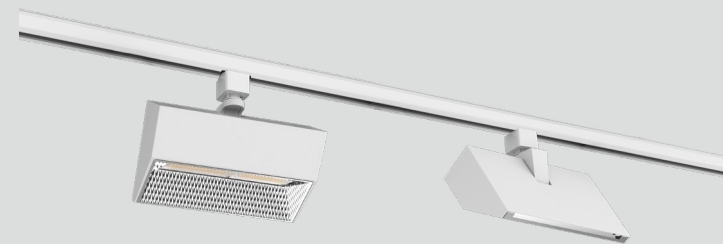
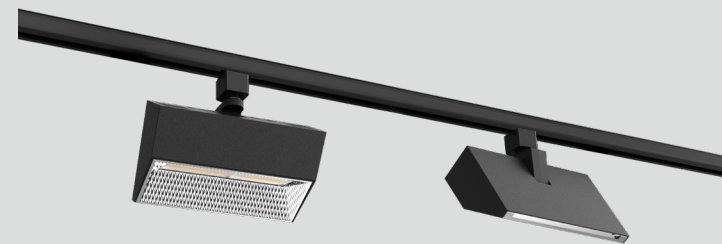
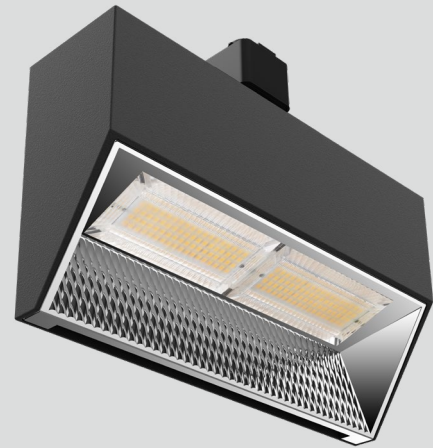

## NOVA Wall Wash Track Head

A versatile wall wash track that simplifies specifications by incorporating all settings into a single SKU while ensuring uniform, wide, and precise illumination.

## Top-To-Bottom Wide and Uniform Lighting

Designed with cutting-edge optics and a faceted reflector, NOVA provides wide and uniform lighting across expansive surfaces from top to bottom, maximizing the illuminated area with reduced number of fixture installed.

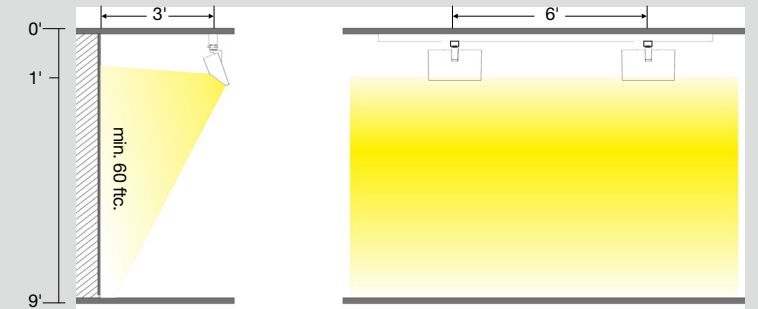

## Effortless Field Selectability

Designed with integral power and CCT switches, NOVA allows for field selection of three lumen levels ranging from 3,000lm to 5,000lm with up to 100lm/W efficacy, and three color temperatures from 3000K, 3500K, and 4000K with high CRI 90 for crisp light and superior color accuracy. Specification for right light output and color is at your fingertips directly in the field.

## SPECIFICATIONS

Series	CRI	CCT	Driver	Adapter	Finish
<b>NOVT</b> NOVA Wall Wash Track	<b>9</b> 90+ CRI	<b>CCTS</b> Selectable CCT 3000 / 3500 / 4000K	<b>DIM120V/UNV</b> 120V, 50/60 Hz, Forward and Reverse Phase Line Voltage Dimming to 5%	<b>J</b> GC and Juno type	<b>WH</b> White
				<b>H</b> Halo Type adapter	<b>BL</b> Black
				<b>L</b> Lightolier Type adapter	

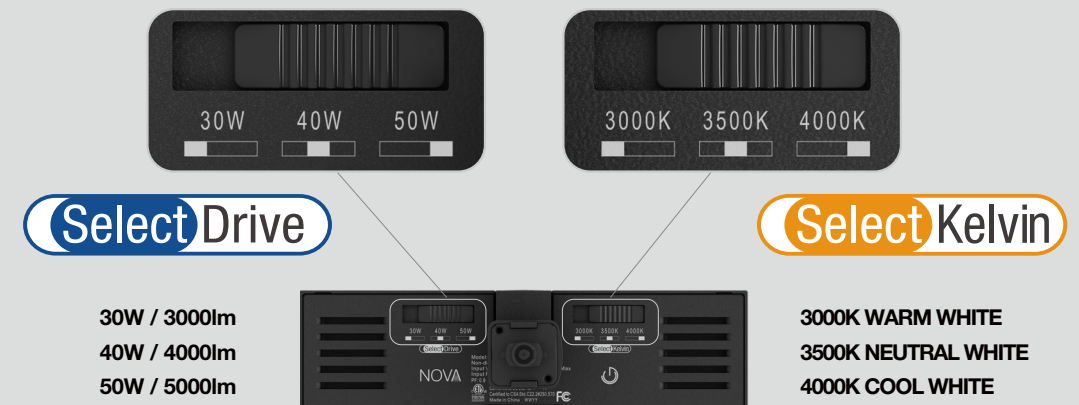

## Fewer Head Count, Refine Space

NOVA provides ample and uniform lighting using fewer fixtures due to its broad light distribution and impressive footcandles. With a spacing range of up to 6 feet between fixtures and 3 feet from the wall, your entire area remains brightly illuminated, ensuring a minimum of 60 footcandles on the wall and an even distribution of light from 1 to 9 feet from the ceiling, even between fixtures. Achieve a refined ambiance with a 'silent ceiling' effect, immersing your space with vibrant illumination.

## Precise and Convenient Light Adjustment

NOVA is engineered with 360° rotating head and 90° pivot design, with assisting light articulation indicators on the arm of the track head, free and precise aiming of the light towards where needed become a breeze.

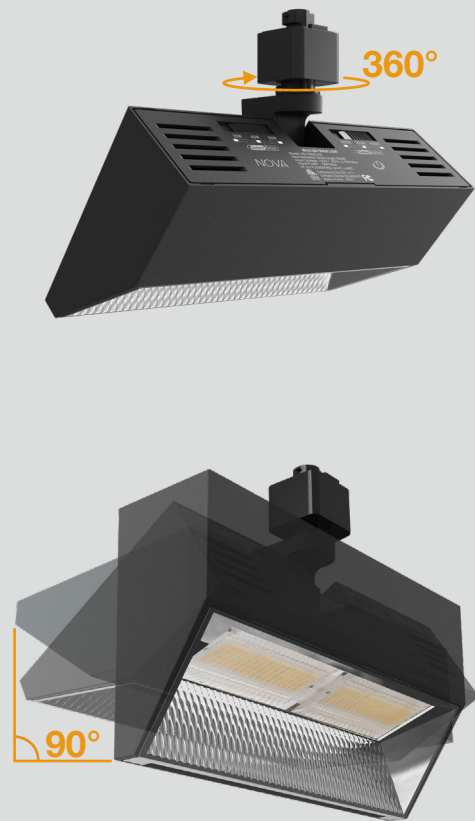

## Complementary Design

The sleek and compact design enables NOVA seamlessly blending into any environment, either installed alone, or work in combination with our ORBIT track and PXCYL cylinder track which designed in the same sleek and contemporary style, for achieving more diversified aesthetics and illumination effect.





# ORBIT TRACK LIGHT

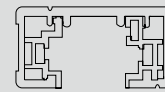

H-Type

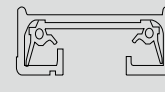

J-Type

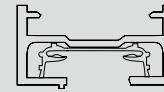

L-Type

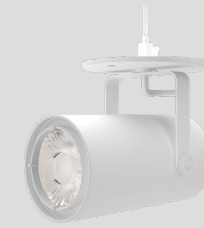

Canopy Mount

## MULTIPLE SYSTEM

H, J, & L track head adapters are available to accommodate the most common track systems. Canopy mounts are ETL listed to be mounted to either ceiling or wall mounted j-boxes, offering design flexibility and consistency.

## FIELD CHANGEABLE TIR OPTICS

Wide range of field interchangeable polycarbonate TIR optics, for clean and smooth beam control, Spot 15°, Narrow Flood 25° and Flood 35° available for each size.

## FIELD SELECTABLE LUMEN

ORBIT track features SelectDrive technology, for field selectable lumen output.

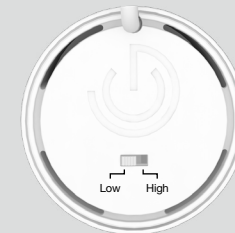

## FULL ACCESSORY SUITE

The ORBIT family is available with a variety of accessories in matching color finishes. The wall wash, snoot and barn doors snap on to the front of the fixture and can be used in conjunction with GREEN CREATIVE filters and lenses.

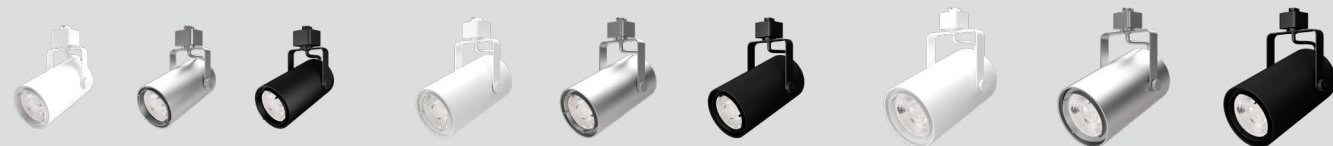
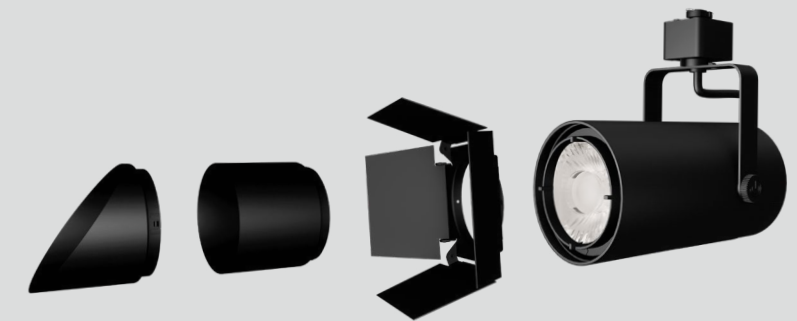

## MEDIA, COLOR FILTERS, LENSES

Define, refine and dramatize your lighting design with media and lenses. Use the Honeycomb, Linear Spread and Solite lenses to reduce glare, spread and soften the edges of any lighting design. Use the Square lenses for highlighting specific painting or architectural details. Use the CCT shifting lenses for unparalleled warmer colors (2400K and 2200K), creating welcoming environments for your most ambitious projects.

## SPECIFICATIONS

Series	Output	CRI	CCT	Beam Angle	Driver	Adapter	Finish
<b>ORB</b> Orbit Series	<b>S</b> Small 700 / 1,000 lumens	<b>9</b> 90+ CRI	<b>27</b> 2700K	<b>SP</b> Spot 15°	<b>DIM120V</b> 120V, 50/60 Hz, Forward and Reverse Phase Line Voltage Dimming to 5%	<b>H</b> Halo	<b>BL</b> Black
	<b>M</b> Medium 1,500 / 2,000 lumens		<b>30</b> 3000K	<b>NR</b> Narrow 25°		<b>J</b> Juno	<b>WH</b> White
	<b>L</b> Large 3,000 / 4,000 lumens	<b>35</b> 3500K	<b>FL</b> Flood 35°	<b>L</b> Lightolier		<b>W</b> Silver	
		<b>40</b> 4000K		<b>CM</b> Canopy Mount			

## ACCESSORY ORDERING INFORMATION

Model Series	Type	Size	Product	Color
<b>ORB</b> Orbit Series	<b>ACC</b> Accessories	<b>S</b> Small	<b>SN</b> Snoot	<b>WH</b> White
		<b>M</b> Medium	<b>WW</b> Wall Wash	<b>BL</b> Black
		<b>L</b> Large	<b>BD</b> Barn Door	
			<b>HC<sup>1</sup></b> Honey Comb	

<sup>1</sup>HC No need to select color for HC.

## OPTIC ORDERING INFORMATION

Model Series	Type	Size	Beam Angle
<b>ORB</b> Orbit Series	<b>OPT</b> Optical Lens	<b>S</b> Small	<b>SP</b> Spot 15°
		<b>M</b> Medium	<b>NR</b> Narrow 25°
		<b>L</b> Large	<b>FL</b> Flood 35°

## MEDIA ORDERING INFORMATION

Model Series	Type	Size	Product
<b>ORB</b> Orbit Series	<b>LENS</b> Lens	<b>S</b> Small	<b>LS</b> Linear Spread
		<b>M</b> Medium	<b>SOL</b> Solite
		<b>L</b> Large	<b>SQ3636</b> Square Lens 36°
			<b>CCT22</b> CCT Shift Lens 2700K to 2200K
			<b>CCT24</b> CCT Shift Lens 2700K to 2400K



The Atom Track offers industry-leading performance in a versatile, compact fixture. With your choice of color temperature, lumen output, track adapter, beam angle, and fixture color, you can tailor this track light to any application. The Atom Track's modular design makes it fully customizable, allowing you to easily make in-field upgrades to the light engine or lens. Snap-on accessories offer even more options, giving you flexibility and variety to your lighting project.

### TRACK MOUNT



### CANOPY MOUNT



- Compact form factor with industry-leading performance
- Meets CA Title 24 requirements
- H, J, L, and Canopy Mount adapters available
- Easy to install, snap-on accessories available

Easy to install snap-on accessories, including wall wash, snoot, honeycomb louver, color shift and square distribution lenses.

### SPECIFICATIONS

Series	Output	CRI	CCT	Beam Angle	Driver	Adapter	Finish
<b>ATM</b> Atom Track Series	<b>6</b> 650 lumens	<b>9</b> 90+ CRI	<b>27</b> 2700K	<b>NR</b> Narrow 25°	<b>DIM120V</b> 120V, 50/60 Hz, Forward and Reverse Phase Line Voltage Dimming to 10%	<b>H</b> Halo	<b>B</b> Matte Black
	<b>10</b> 1,050 lumens		<b>30</b> 3000K	<b>FL</b> Flood 35°		<b>J</b> Juno	<b>W</b> Matte White
		<b>35</b> 3500K		<b>L</b> Lightolier			
		<b>40</b> 4000K		<b>CM</b> Canopy Mount			

### ACCESSORIES

Product	Model	Description
35037	ATM/A/SN/WH	Snoot: Matte White
35038	ATM/A/SN/BL	Snoot: Matte Black
35040	ATM/A/HC/WH	Honeycomb Louver: Matte White Ring
35041	ATM/A/HC/BL	Honeycomb Louver: Matte Black Ring
35043	ATM/A/WW/WH	Wall Wash: Matte White
35044	ATM/A/WW/BL	Wall Wash: Matte Black
35811	MR/ACC/RED	Shift lens Red
35812	MR/ACC/GRE	Shift lens Green
35813	MR/ACC/BLE	Shift lens Blue
35814	MR/ACC/YLW	Shift lens Yellow
36915	ORB/LENS/M/CCT22	Medium - CCT Shift Lens 2700K to 2200K
36916	ORB/LENS/M/CCT24	Medium - CCT Shift Lens 2700K to 2400K
35818	MR/ACC/SQ2525	Square distribution lens 25°
35819	MR/ACC/SQ3636	Square distribution lens 36°



### Versatile Sizes and Finishes

SOL Gimbal Track Head is designed to fit lamps in PAR20, PAR30 short neck and PAR38 form factors. Choose from white or black finishes to effortlessly match your decor style.

The E26 medium screw base design ensures simple installation and removal. It's designed to be future-proof, allowing for upgrades and maintenance, giving you peace of mind that your fixture will endure the test of time.



### Maximum Horizontal and Vertical Swivel

Featuring its 2-plane gimbal design, the SOL Gimbal series allows for maximum horizontal and vertical swivel, enabling precise aiming and adding a touch of elegance to any environment.

Equipped with an E26 medium base and compatible with both H-Type and J-Type adapters, it seamlessly integrates with a variety of Track Rails.

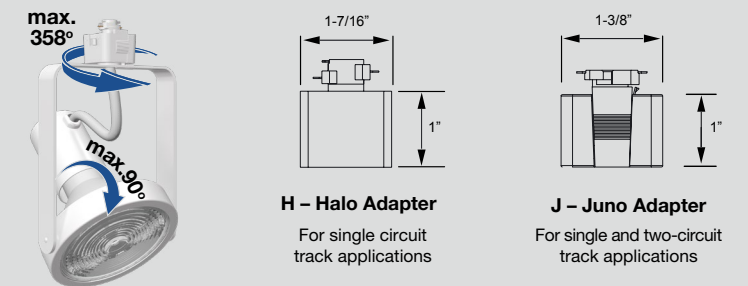

### Perfect Companion with GREEN CREATIVE PAR Lamps

SOL Gimbal Track Heads are designed as perfect companion with GREEN CREATIVE PAR lamps tailored for your specific lighting requirements. REFINE PAR lamps series deliver superior light performance with best color accuracy and efficiency. The AdjustaPAR lamps series offers optimal flexibility for adjusting color temperature and beam angle in the field. Value Select PAR lamps series brings best value solution for everyday contractor projects.

#### Best Performance



#### Best Flexibility



#### Best Value



### SPECIFICATIONS

Series	Track Style	Lamp Type	Lamp base	Adapter	Finish
<b>SOL</b> SOL TRACK HEAD SERIES	<b>GR</b> Gimbal Ring	<b>PAR20</b> PAR20 Ready	<b>E26</b> E26 lamp base socket adapter	<b>J</b> GC and Juno type	<b>WH</b> White
		<b>PAR30</b> PAR30 Ready		<b>H</b> Halo Type adapter	<b>BL</b> Black
		<b>PAR38</b> PAR38 Ready			

# SINGLE CIRCUIT J-TYPE TRACK SYSTEM

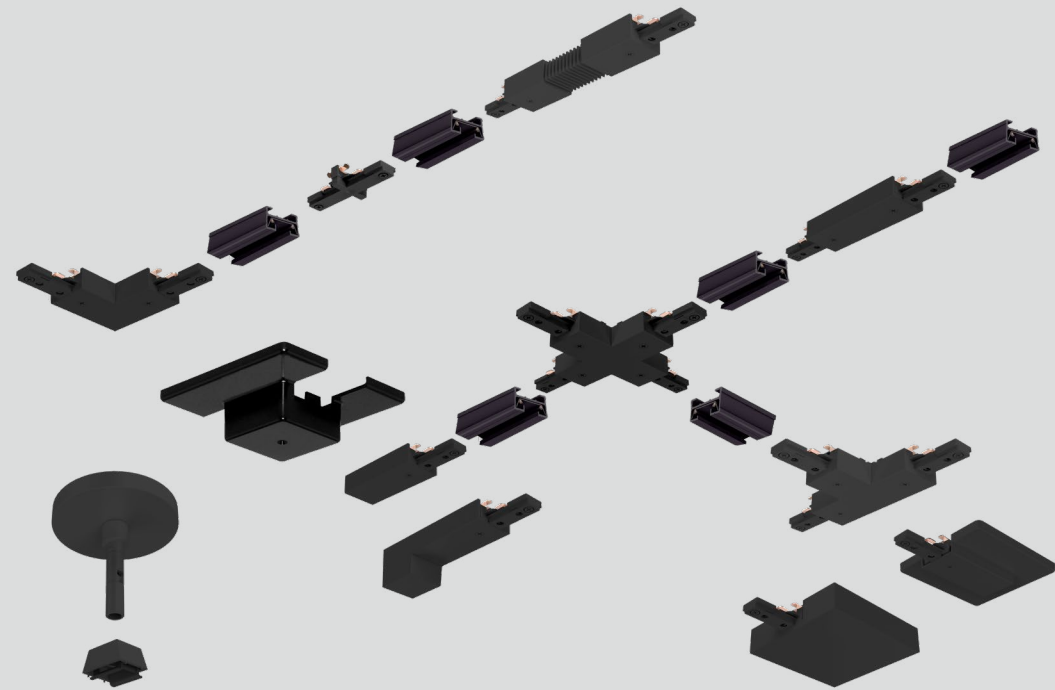

- Extruded aluminum, “I-Beam” design construction for strength and rigidity
- Available standard in 24”, 48” and 96” lengths
- Field-cuttable for custom lengths
- Black, white and silver finishes available
- Rated for 20A at 120V, 60Hz. Maximum power rating is 2.4 kW
- Surface, cable or pendant installation options
- Mechanical polarity with a visual indicator simplifies installation
- All track system components are cULus listed for dry location
- Use with GREEN CREATIVE ATOM and ORBIT track fixtures
- Compatible with all J-Type track heads

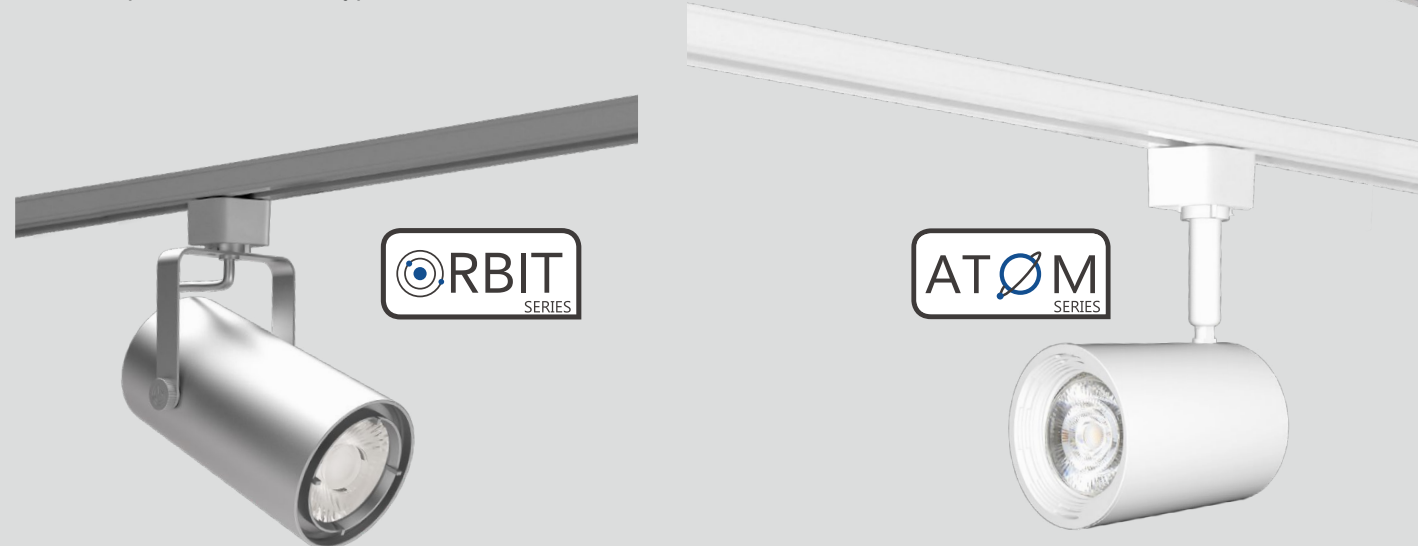
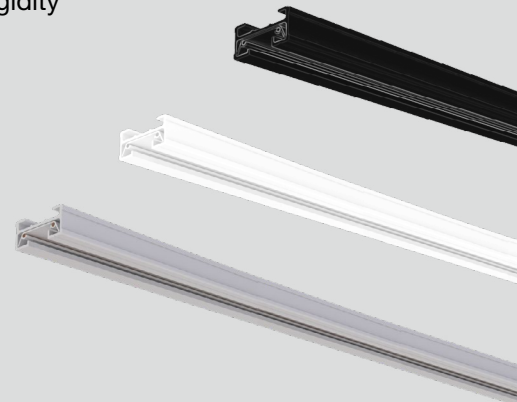

GREEN CREATIVE Single Circuit J-Type Track System is compatible with all GREEN CREATIVE Track Fixtures with J-type adapter, including the ATOM and ORBIT track lines.

## SPECIFICATIONS

Series	Length	Circuit	Finish
<b>TRKJ</b> Track J-type	<b>24</b> 24in. (2ft) Length	<b>1C</b> Single Circuit	<b>BL</b> Black
	<b>48</b> 48in. (4ft) Length		<b>WH</b> White
	<b>96</b> 96in. (8ft) Length		<b>SV</b> Silver

POWER FEEDS			
Series	Type	Circuit	Finish
<b>TRKJ</b> Track J-type	<b>ENDF</b> Live End Feed	<b>1C</b> Single Circuit	<b>BL</b> Black
	<b>SCF</b> Surface Conduit Feed		<b>WH</b> White
	<b>ENDFCOV</b> End Feed with Cover		<b>SV</b> Silver
	<b>FCPY</b> Floating Canopy Feed		
	<b>TBENDF</b> T-Bar End Feed		
	<b>END</b> End Cap		

MOUNTING AND SUSPENSION			
Series	Type	Circuit	Finish
<b>TRKJ</b> Track J-type	<b>STCPY</b> Stem Canopy	<b>1C</b> Single Circuit	<b>BL</b> Black
	<b>STEMSLOPECPY</b> Stem Slope Ceiling Canopy		<b>WH</b> White
			<b>SV</b> Silver

Series	IPS	Type	Finish	
<b>STEM</b>	<b>1-4</b> 1/4" IPS	*	<b>BL</b> Black	
		<b>1-4COUPLING*</b> 1/4" IPS Stem Coupling Extender	<b>12</b> 12" long	<b>WH</b> White
			<b>24</b> 24" long	<b>SV</b> Silver
			<b>36</b> 36" long	
		<b>48</b> 48" long		

\*No length for coupling extender

CONNECTORS			
Series	Type	Circuit	Finish
<b>TRKJ</b> Track J-type	<b>MIC</b> Mini I Connector	<b>1C</b> Single Circuit	<b>BL</b> Black
	<b>IC</b> I Connector		<b>WH</b> White
	<b>IFC</b> I Flex Connector		<b>SV</b> Silver
	<b>LC</b> L Connector		
	<b>TC</b> T Connector		
	<b>TCR</b> T Connector Reverse Polarity		
	<b>XC</b> X Connector		

Series	Type	Finish
<b>TRK</b> Track	<b>SWIRCOV</b> Wire Way Cover	<b>BL</b> Black
	<b>COVPLATE</b> Square cover plate	<b>WH</b> White
		<b>SV</b> Silver

Series	Type
<b>TRK</b> Track	<b>TBMOUNTCLIP</b> Slide-on T-bar mounting clip



GREENCREATIVE

**Your Partner for Professional Lighting Solutions**

2024 H1

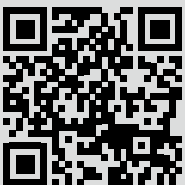

**Tel / Fax: (866) 774-5433**

**info@greencreative.com**

**www.greencreative.com**

 / GREENCREATIVELED

 / GClightingLED

 / GREEN-CREATIVE

 ILLUMUS.

An ILLUMUS Brand

www.ILLUMUS.com