

Project Name:	Type:
Part Number:	Date:

# EXTERNAL DRIVER T5 (UL TYPE C)

## FEATURES

- Replaces 2' / 3' / 4' T5 & 4' T5HO fluorescent lamp
- Compatible with GREEN CREATIVE external drivers only
- Flicker Free (percent flicker and flicker index are less than three percent)
- Utilizes existing lamp holders – shunted or non-shunted
- Ultra-high efficacy up to 158 LPW
- Opaque plastic lens reduces glare
- 270° wide light emitting area
- 0-10V dimming - dims to OFF with SelectDrive driver, dims to 10% with single wattage driver
- Field select from three lumen outputs using SelectDrive driver
- Parallel output driver requires no minimum lamp load to operate properly
- Suitable for use in enclosed fixture and damp location
- Meets NSF Requirements (use of a shatter guard required)
- Fixture operating temperature: -4°F to 95°F (-20°C to 35°C)
- Lamp ambient temperature: -4°F to 113°F (-20°C to 45°C)
- Rated lifetime(L70) up to: 60,000hrs
- 5 year limited warranty\* / 10 year available (see EXTENDED WARRANTIES table for information)
- Suitable for indoor general lighting & industrial high bay application
- Lamp and driver DLC listed as a system (4' T5 lamp based systems only; DLC does not qualify 2' or 3' T5 lamps at this time)
- NSF (National Sanitation Foundation) certified for Food Zone (Non-Contact), Splash, and Non-Food Zones



### DIGITAL NAVIGATION

Explore the spec sheet through the links below

- [SPECIFICATIONS](#)
- [DIMENSION & WEIGHT](#)
- [INSTALLATION](#)
- [ACCESSORY ORDERING INFORMATION](#)
- [LOGISTIC INFORMATION](#)
- [EXTENDED WARRANTIES](#)
- [CERTIFICATION INFORMATION \(DLC KITS REFERENCES\)](#)



## FOCUS FEATURE

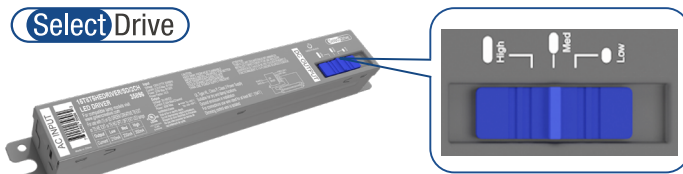

Selectable Output			
Output	Low	Med	High
Current	210mA	250mA	300mA

## SPECIFICATIONS

EXTERNAL DRIVER											
Product	Model	Max. Lamp Quantity	Input Voltage	Input Freq. (Hz)	Max.Input Current (A)	Output Voltage (V)	Output Current (mA)	Dim	Max Case Temperature (°C/°F)	Power Factor	THD
35896	15T8T5HEDRIVER/SD/2CH	2	120-277V	50/60	0.31	30-48VDC	300mA/250mA/210mA (+/-5%) *2	0-10V	90/194	0.9	<20%
35897	15T8T5HEDRIVER/SD/4CH	4	120-277V	50/60	0.60	30-48VDC	300mA/250mA/210mA (+/-5%) *4	0-10V	90/194	0.9	<20%
98259	15T8T5HEDRIVER/2CH/R	2	120-277V	50/60	0.31	30-48VDC	300mA * 2	0-10V	90/194	0.9	<20%
98260	15T8T5HEDRIVER/4CH/R	4	120-277V	50/60	0.60	30-48VDC	300mA * 4	0-10V	90/194	0.9	<20%
98261	24T5HODRIVER/2CH/R	2	120-277V	50/60	0.48	24-42VDC	550mA * 2	0-10V	90/194	0.9	<20%
98262	24T5HODRIVER/4CH/R	4	120-277V	50/60	0.94	24-42VDC	550mA * 4	0-10V	85/185	0.9	<20%

Note: All rights reserved. All sizes and specifications are subject to change at any time without notice.



# EXTERNAL DRIVER T5 (UL TYPE C)

## SPECIFICATIONS

### LAMP

Product	Model	Nominal Length	Equiv.	Wattage (W)	Lumens	CCT	Efficacy (LPW)	Life (hrs)	CRI	Beam Angle	DLC	DOE
98321	22T5HO/4F/830/EXT	4'	54W	22	3,200	3000K	145	50,000	82	120°	✓	✓
98322	22T5HO/4F/835/EXT	4'	54W	22	3,200	3500K	145	50,000	82	120°	✓	✓
98323	22T5HO/4F/840/EXT	4'	54W	22	3,400	4000K	155	50,000	82	120°	✓	N.A.
98324	22T5HO/4F/850/EXT	4'	54W	22	3,400	5000K	155	50,000	82	120°	✓	N.A.
98312	13.5T5HE/4F/830/EXT	4'	28W	13.5	1,800	3000K	133	60,000	82	120°	✓	✓
98313	13.5T5HE/4F/835/EXT	4'	28W	13.5	1,850	3500K	137	60,000	82	120°	✓	✓
98314	13.5T5HE/4F/840/EXT	4'	28W	13.5	2,000	4000K	148	60,000	82	120°	✓	✓
98310	11T5HE/3F/835/EXT	3'	21W	11	1,550	3500K	141	60,000	82	120°	N.A.	✓
98311	11T5HE/3F/840/EXT	3'	21W	11	1,650	4000K	150	60,000	82	120°	N.A.	✓
98307	9.5T5HE/2F/835/EXT	2'	14W	9.5	1,400	3500K	147	60,000	82	120°	N.A.	✓
98308	9.5T5HE/2F/840/EXT	2'	14W	9.5	1,500	4000K	158	60,000	82	120°	N.A.	✓

### LAMP & DRIVER SYSTEM

Product	Model	CCT	98259 15T8T5HEDRIVER/2CH/R				98260 15T8T5HEDRIVER/4CH/R			
			1 Lamp		2 Lamps		3 Lamps		4 Lamps	
			System Power	Lumens	System Power	Lumens	System Power	Lumens	System Power	Lumens
98312	13.5T5HE/4F/830/EXT	3000K	15	1,800	30	3,600	45	5,400	60	7,200
98313	13.5T5HE/4F/835/EXT	3500K	15	1,850	30	3,700	45	5,550	60	7,400
98314	13.5T5HE/4F/840/EXT	4000K	15	2,000	30	4,000	45	6,000	60	8,000
98310	11T5HE/3F/835/EXT	3500K	13	1,550	26	3,100	39	4,650	52	6,200
98311	11T5HE/3F/840/EXT	4000K	13	1,650	26	3,300	39	4,950	52	6,600
98307	9.5T5HE/2F/835/EXT	3500K	12	1,400	24	2,800	36	4,200	48	5,600
98308	9.5T5HE/2F/840/EXT	4000K	12	1,500	24	3,000	36	4,500	48	6,000

Product	Model	CCT	98261 24T5HODRIVER/2CH/R				98262 24T5HODRIVER/4CH/R			
			1 Lamp		2 Lamps		3 Lamps		4 Lamps	
			System Power	Lumens	System Power	Lumens	System Power	Lumens	System Power	Lumens
98321	22T5HO/4F/830/EXT	3000K	26	3,200	52	6,400	78	9,600	104	12,800
98322	22T5HO/4F/835/EXT	3500K	26	3,200	52	6,400	78	9,600	104	12,800
98323	22T5HO/4F/840/EXT	4000K	26	3,400	52	6,800	78	10,200	104	13,600
98324	22T5HO/4F/850/EXT	5000K	26	3,400	52	6,800	78	10,200	104	13,600

### LAMP & SelectDrive EXTERNAL DRIVER LUMEN OUTPUT GUIDE

LED Lamp model	Lamp & Driver system lumen output (based on 4000K)					
	15T8T5HEDRIVER/SD/2CH 15T8T5HEDRIVER/SD/4CH					
	Low (Power)	Low (Lumens)	Med (Power)	Med (Lumens)	High (Power)	High (Lumens)
13.5T5HE/4F/8XX/EXT	9.5	1,400 lm	11.3	1,650 lm	13.5	2,000 lm
11T5HE/3F/8XX/EXT	7.7	1,100 lm	9.2	1,300 lm	11.0	1,650 lm
9.5T5HE/2F/8XX/EXT	6.7	1,000 lm	7.9	1,200 lm	9.5	1,500 lm

## DIMENSION & WEIGHT

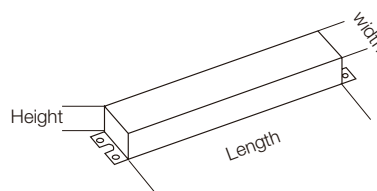
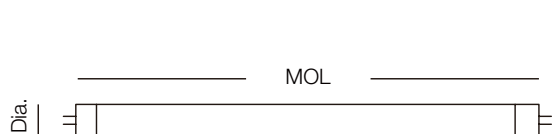

Model	Base	MOL	Dia.	Weight
9.5T5HE/2F/xxx/EXT	G5	22"	11/16"	0.17lb
11T5HE/3F/xxx/EXT	G5	34"	11/16"	0.26lb
13.5T5HE/4F/xxx/EXT	G5	45-3/4"	11/16"	0.33lb
22T5HO/4F/xxx/EXT	G5	45-3/4"	11/16"	0.33lb

Where xxx means 824-965 which indicates CRI and color temperature

Model	Length	Width	Height	Weight
15T8T5HEDRIVER/SD/2CH	9-1/2"	1-5/16"	1-3/16"	1.0 lb
15T8T5HEDRIVER/SD/4CH	9-1/2"	1-5/16"	1-3/16"	1.0 lb
15T8T5HEDRIVER/2CH/R	9-1/2"	1-5/16"	1-3/16"	1.0 lb
15T8T5HEDRIVER/4CH/R	9-1/2"	1-5/16"	1-3/16"	1.0 lb
24T5HODRIVER/2CH/R	9-1/2"	1-5/16"	1-3/16"	1.0 lb
24T5HODRIVER/4CH/R	9-1/2"	1-3/4"	1-3/16"	1.4 lb



# EXTERNAL DRIVER T5 (UL TYPE C)

## INSTALLATION

### EXTERNAL LED DRIVER INSTALLATION

#### Double-ended Installation

- For shunted & non-shunted lamp holders
- Not polarity sensitive, lamps can be wired at either end

1 LAMP

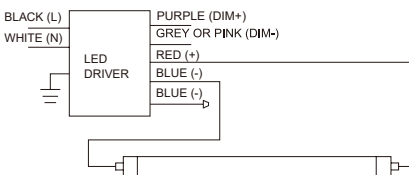

4 LAMPS

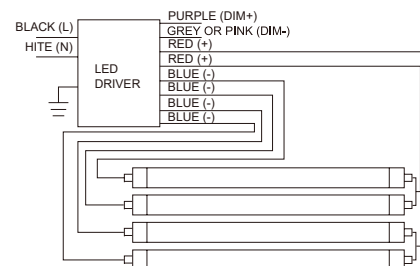

#### Single-ended Installation

- For non-shunted lamp holders only
- Not polarity sensitive, lamps can be wired at either end

1 LAMP

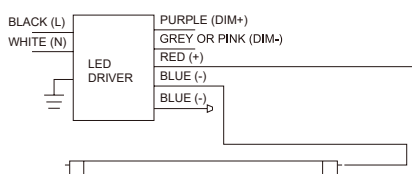

4 LAMPS

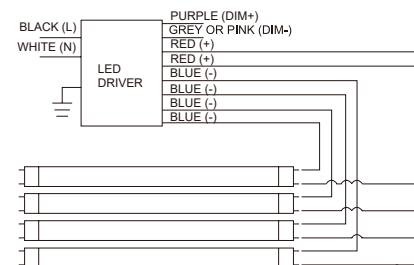

### FULHAM EMERGENCY DRIVER INSTALLATION

1 LAMP

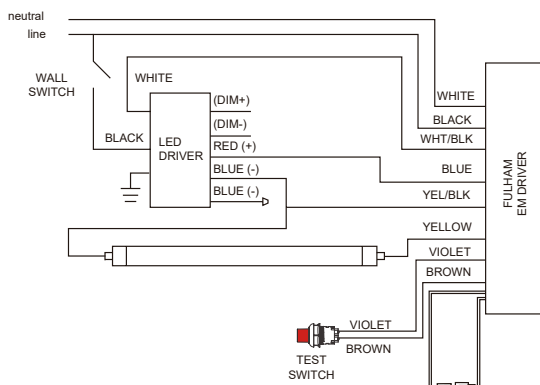

1 LAMP

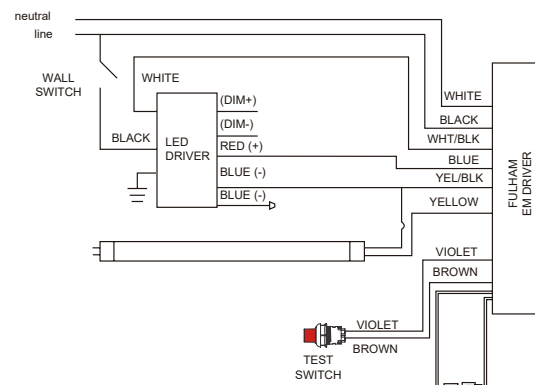

4 LAMPS

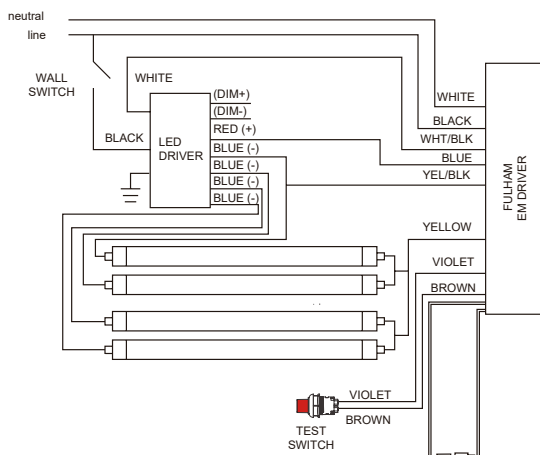

4 LAMPS

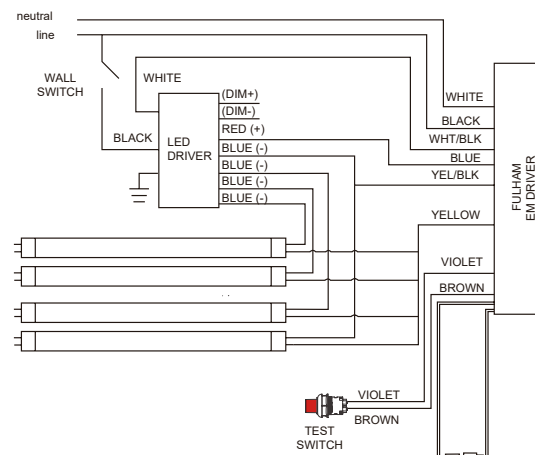







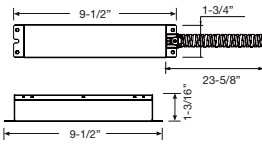

Type	Model No	FULHAM EM DRIVER	
		Lumen output level at EM mode	
		FHSCP-UNV3-10W-LSD-A	FHSCP-UNV-17WL FHSCP-UNV3-15W-LSD-A
T5	9.5T5HE/2F/8XX/EXT	113%	-
	11T5HE/3F/8XX/EXT	97%	-
	13.5T5HE/4F/8XX/EXT	79%	-
	22T5HO/4F/8XX/EXT	49%	77%

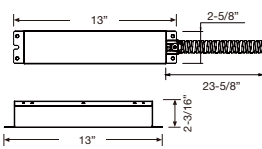
Note: All rights reserved. All sizes and specifications are subject to change at any time without notice.

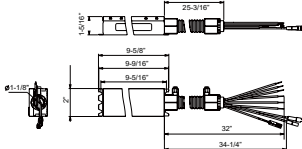

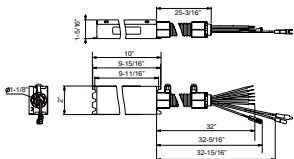
# EXTERNAL DRIVER T5 (UL TYPE C)

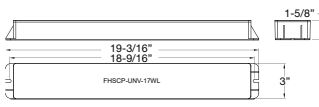
ACCESSORY ORDERING INFORMATION					
Product	Model	Description	Pictures	Dimensions	Compatible Skus
37934	8EMINVERTER	California Title 20 Compliant 8W Emergency LED Inverter (Field Installation)			9.5T5HE/2F/8xx/EXT 11T5HE/3F/8xx/EXT 13.5T5HE/4F/8xx/EXT 22T5HO/4F/8xx/EXT
38096	24EMINVERTER	California Title 20 Compliant 24W Emergency LED Inverter (Field Installation)			9.5T5HE/2F/8xx/EXT 11T5HE/3F/8xx/EXT 13.5T5HE/4F/8xx/EXT 22T5HO/4F/8xx/EXT
FHSCP-UNV3-10W-L-SD-A	FHSCP-UNV3-10W-L-SD-A	10W EM Driver 100-347V California Title 20 Compliant (Field Installation)			9.5T5HE/2F/8xx/EXT 11T5HE/3F/8xx/EXT 13.5T5HE/4F/8xx/EXT 22T5HO/4F/8xx/EXT
FHSCP-UNV3-15W-L-SD-A	FHSCP-UNV3-15W-L-SD-A	15W EM Driver 100-347V California Title 20 Compliant Field Installation			22T5HO/4F/8xx/EXT
FHSCP-UNV-17WL	FHSCP-UNV-17WL	17W EM Driver 120-277V California Title 20 Compliant Field Installation			22T5HO/4F/8xx/EXT

LOGISTIC INFORMATION						
Model	Master Carton			Shipping Carton		
	Case Qty	Case Dimensions (LxWxH)	Case Weight	Case Qty	Case Dimensions (LxWxH)	Case Weight
9.5T5HE/2F/xxx/EXT	6PCS	23" x 2-1/2" x 1-3/4"	1.4lb	24PCS	25-3/16" x 5-13/16" x 4-13/16"	6.2lb
11T5HE/3F/xxx/EXT	6PCS	34-13/16" x 2-1/2" x 1-3/4"	2.1lb	24PCS	37" x 5-13/16" x 4-13/16"	9.3lb
13.5T5HE/4F/xxx/EXT	6PCS	46-5/8" x 2-1/2" x 1-3/4"	2.7lb	24PCS	48-13/16" x 5-13/16" x 4-13/16"	12.3lb
22T5HO/4F/xxx/EXT	6PCS	46-5/8" x 2-1/2" x 1-3/4"	2.7lb	24PCS	48-13/16" x 5-13/16" x 4-13/16"	12.3lb
15T8T5HEDRIVER/SD/2CH	6PCS	9-7/8" x 5-5/8" x 2-3/4"	5.69 lb	24PCS	11-7/8" x 10-5/6" x 6-11/16"	22.82 lb
15T8T5HEDRIVER/SD/4CH	6PCS	9-7/8" x 5-5/8" x 2-3/4"	6.22 lb	24PCS	11-7/8" x 10-5/6" x 6-11/16"	24.69 lb
15T8T5HEDRIVER/2CH/R	6PCS	10-1/4" x 5-11/16" x 3-1/8"	4.85lb	24PCS	12-3/16" x 10-5/8" x 6-7/8"	20.5lb
15T8T5HEDRIVER/4CH/R	6PCS	10-1/4" x 5-11/16" x 3-1/8"	4.85lb	24PCS	12-3/16" x 10-5/8" x 6-7/8"	20.5lb
24T5HODRIVER/2CH/R	6PCS	10-1/4" x 5-11/16" x 3-1/8"	6.17lb	24PCS	12-3/16" x 10-5/8" x 6-7/8"	22.49lb
24T5HODRIVER/4CH/R	6PCS	10-1/4" x 5-11/16" x 3-1/8"	6.17lb	24PCS	12-3/16" x 10-5/8" x 6-7/8"	22.49lb

EXTENDED WARRANTIES**	
Model	Description***
9.5T5/2F/EXT/10YEARWARRANTY	10 Year warranty for 9.5T5HE/2F/8xx/EXT/yy
11T5/3F/EXT/10YEARWARRANTY	10 Year warranty for 11T5HE/3F/8xx/EXT/yy
13.5T5/4F/EXT/10YEARWARRANTY	10 Year warranty for 13.5T5HE/4F/8xx/EXT/yy
15T8T5HEDRIVER/10YEARWARRANTY/2CH	10 Year warranty for 15T8T5HEDRIVER/2CH/yy
15T8T5HEDRIVER/10YEARWARRANTY/4CH	10 Year warranty for 15T8T5HEDRIVER/4CH/yy

FOOTNOTES: \*\* Warranty based on a maximum of 4,368 annual operating hours (per year for ten years) and exposure to a maximum fixture operating temperature of 80°F / 27°C.  
\*\*\* xx - Refers to the CCT yy - Refers to model generations within the same nominal performance. Typically blank, 'R', or 'RC'



# EXTERNAL DRIVER T5 (UL TYPE C)

## CERTIFICATION INFORMATION (DLC KITS REFERENCES)

Model No. (DLC)	Lamp Model	Lamp Qty	External Driver Model	DLC Product ID
22T5HO/4F/830/EXT/A3/R	98321 22T5HO/4F/830/EXT	3	98262 24T5HODRIVER/4CH/R	PL6C5CCAYO3C
22T5HO/4F/830/EXT/A4/R		4		PLC02Y2ZAY2S
22T5HO/4F/835/EXT/A3/R	98322 22T5HO/4F/835/EXT	3		PLATC4QDA2S4
22T5HO/4F/835/EXT/A4/R		4		PLUOIFXM0YOP
22T5HO/4F/840/EXT/A3/R	98323 22T5HO/4F/840/EXT	3		PLJ3TT7VKL1U
22T5HO/4F/840/EXT/A4/R		4		PLNKVT1MU06L
22T5HO/4F/850/EXT/A3/R	98324 22T5HO/4F/850/EXT	3		PLXPLB8246MP
22T5HO/4F/850/EXT/A4/R		4		PL115NT0GDQQ
13.5T5HE/4F/830/EXT/A2/R	98312 13.5T5HE/4F/830/EXT	2	98259 15T8T5HEDRIVER/2CH/R	PLQFJ83IDHDQ
13.5T5HE/4F/830/EXT/A3/R		3	98260 15T8T5HEDRIVER/4CH/R	PL7N81FORZFL
13.5T5HE/4F/830/EXT/A4/R	4	PL0H6007SJRI		
13.5T5HE/4F/835/EXT/A2/R	98313 13.5T5HE/4F/835/EXT	2	98259 15T8T5HEDRIVER/2CH/R	PLVVMTXBJMXL
13.5T5HE/4F/835/EXT/A3/R		3	98260 15T8T5HEDRIVER/4CH/R	PLBB5GGWZZWE
13.5T5HE/4F/835/EXT/A4/R	4	PL75DXO9CJ1J		
13.5T5HE/4F/840/EXT/A2/R	98314 13.5T5HE/4F/840/EXT	2	98259 15T8T5HEDRIVER/2CH/R	PL05CL5SYVU0
13.5T5HE/4F/840/EXT/A3/R		3	98260 15T8T5HEDRIVER/4CH/R	PLFUGKQ21ZB0
13.5T5HE/4F/840/EXT/A4/R	4	PLX6Y4NYQNWD		
13.5T5HE/4F/830/EXT/SD/A2	98312 13.5T5HE/4F/830/EXT	2	35896 15T8T5HEDRIVER/SD/2CH	PYNWAT0U
13.5T5HE/4F/835/EXT/SD/A2	98313 13.5T5HE/4F/835/EXT			PIQEFADZ
13.5T5HE/4F/840/EXT/SD/A2	98314 13.5T5HE/4F/840/EXT			PLE7OV3O
13.5T5HE/4F/830/EXT/SD/A3	98312 13.5T5HE/4F/830/EXT	3	35897 15T8T5HEDRIVER/SD/4CH	P8J77KKV
13.5T5HE/4F/830/EXT/SD/A4		4		P2TOBKJB
13.5T5HE/4F/835/EXT/SD/A3	98313 13.5T5HE/4F/835/EXT	3		PFKUCEE2
13.5T5HE/4F/835/EXT/SD/A4		4		PB4ZDTLJ
13.5T5HE/4F/840/EXT/SD/A3	98314 13.5T5HE/4F/840/EXT	3		P85IRU14
13.5T5HE/4F/840/EXT/SD/A4		4		PKOG2NG0