

| | |
|---------------|-------|
| Project Name: | Type: |
| Part Number: | Date: |

3N1 9" SURFACE MOUNT

SPECIFICATION FEATURES

- **Mechanical** - Die cast aluminum heat sink. Polycarbonate trim. Smooth diffuse polycarbonate lens. Galvanized steel bracket mounts to industry standard 4" junction boxes from below the ceiling.
- **Electrical** - Universal 120-277V or 120V only, 50/60 Hz drivers available. Universal voltage, 0-10V drivers are dimmable to 5%. 120V drivers are dimmable to 10% using TRIAC or ELV dimmers.
- **Optical** - Edge lighting technology featuring a PMMA light guide plate and smooth polycarbonate lens ensures an even light emitting surface. 110° beam angle. Using SelectKelvin technology, field select color temperature between 3000K/3500K/4000K with a minimum of 90 CRI.
- **Thermal** - Die cast heat sink maximizes passive thermal management and achieves a L70 rated lifetime of 50,000 hours. Ambient temperature rated from -22°F to 95°F (-30°C to 35°C).
- **Compliance and Warranty** - ETL Classified and Listed for wet locations. Certified air-tight per ASTM 283-04. IC Rated for direct contact with insulation. Complies with FCC 47CFR Part 15B consumer limits for EMI/RFI emissions. Compliant with NFPA® 70, NEC® Section 410.16 (A)(3) and 410.16 (C)(5). 5 year parts warranty for complete fixture.



042824



BENEFITS

- Installs almost anywhere with Air-Tight, IC and Wet Location ratings
- Three mounting options, with J-box, recessed housing or direct ceiling
- Field selectable CCT
- 0-10V or 120V dimmable

APPLICATIONS

- Commercial – Offices, Common Areas, Vestibules, Storage Closets
- Residential – Bathrooms, Laundry Rooms, Kitchens, Closets, Garages
- Hospitality – Hallways, Bathrooms, Bedrooms, Storage Rooms

ORDERING INFORMATION

| Series | Size | CRI | CCT | Dimming |
|---|---|---|---|---|
| <input checked="" type="checkbox"/> 3N1 3 N 1 | <input checked="" type="checkbox"/> 9 9" 1250lm | <input checked="" type="checkbox"/> 90 CRI 90 | <input checked="" type="checkbox"/> CCTS Selectable CCT 3000/3500/4000K | <input type="checkbox"/> DIM120V 120V Forward and Reverse Phase Dimming <input type="checkbox"/> DIM010UNV Universal 120-277V, 0-10V dimming |

Note: Factory setting at 3500K CCT.

LINE DRAWINGS

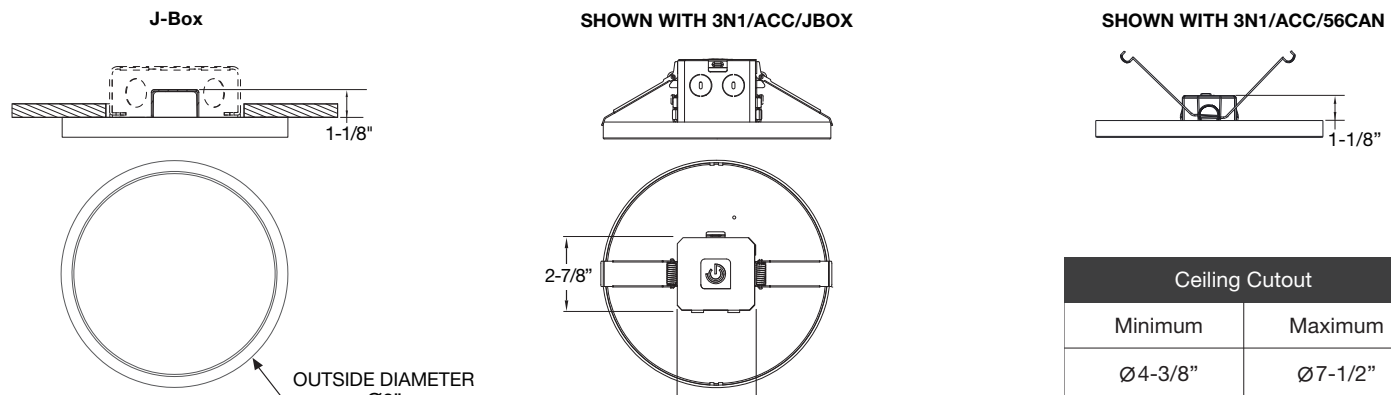

3N1 9" SURFACE MOUNT

INSTALLATION METHODS

Junction Box Mount

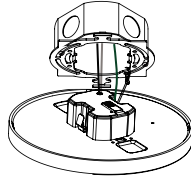

5/6" Recessed Housing

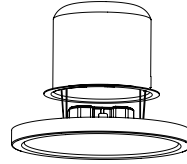

Direct Ceiling Mount

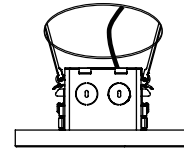

TECHNICAL INFORMATION

| Dimming | Input Voltage | Input Frequency | Input Current | Input Power | THD Power | Power Factor |
|------------|---------------|-----------------|---------------|-------------|-----------|--------------|
| DIM120V | 120V | 50 / 60Hz | 0.127A max | 16.5W | <20% | >0.9 |
| DIM010VUNV | 120V | 50 / 60Hz | 0.125A max | 16.5W | <20% | >0.9 |
| | 277V | | 0.062A max | | | |

PHOTOMETRY

3N1/9/90/CCTS/DIM120V (3500K Selected)

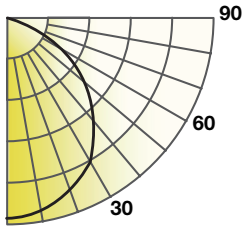

Lumens: 1,314 lm
 CBCP: 454 cd
 Power: 16.5 W
 Efficacy: 80 lm/W
 CRI: 90+
 Spacing Criteria: 1.26
 Beam Angle: 113°

| Candlepower Distribution | |
|--------------------------|--------------|
| Angle (°) | Average (cd) |
| 10 | 453 |
| 20 | 425 |
| 30 | 388 |
| 40 | 337 |
| 50 | 276 |
| 60 | 201 |
| 70 | 124 |
| 80 | 52 |
| 90 | 0 |

| Initial Footcandles | | |
|---------------------|----|---------------|
| Height (ft) | Fc | Diameter (ft) |
| 8 | 11 | 24.4 |
| 10 | 7 | 30.4 |
| 12 | 5 | 36.5 |
| 14 | 3 | 42.6 |
| 16 | 3 | 48.7 |

| Zonal Lumen Summary | | |
|---------------------|--------|----------|
| Zone | Lumens | %Fixture |
| 0-30 | 355 | 27% |
| 0-40 | 583 | 45% |
| 0-60 | 1,033 | 79% |
| 0-90 | 1,314 | 100% |

3N1/9/90/CCTS//DIM010UNV (3500K Selected)

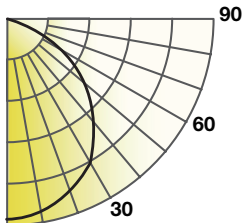

Lumens: 1,277 lm
 CBCP: 440 cd
 Power: 15.2 W
 Efficacy: 84 lm/W
 CRI: 90+
 Spacing Criteria: 1.28
 Beam Angle: 114°

| Candlepower Distribution | |
|--------------------------|--------------|
| Angle (°) | Average (cd) |
| 10 | 439 |
| 20 | 412 |
| 30 | 377 |
| 40 | 328 |
| 50 | 267 |
| 60 | 196 |
| 70 | 122 |
| 80 | 52 |
| 90 | 0 |

| Initial Footcandles | | |
|---------------------|----|---------------|
| Height (ft) | Fc | Diameter (ft) |
| 8 | 10 | 24.8 |
| 10 | 7 | 31.0 |
| 12 | 5 | 37.2 |
| 14 | 3 | 43.4 |
| 16 | 3 | 49.6 |











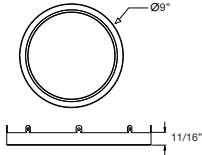

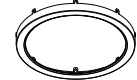
| Zonal Lumen Summary | | |
|---------------------|--------|----------|
| Zone | Lumens | %Fixture |
| 0-30 | 344 | 27% |
| 0-40 | 566 | 45% |
| 0-60 | 1,004 | 79% |
| 0-90 | 1,277 | 100% |

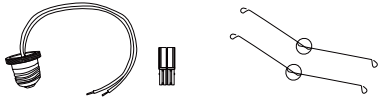

3N1 9" SURFACE MOUNT

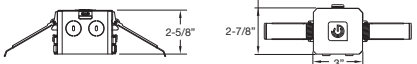
| NOMINAL PERFORMANCE | | | | | | |
|---------------------|------------------------|-------|--------------|-------|--------------|-------|
| | 3N1/9/90/CCTS/DIM/xxxx | | | | | |
| CCT | 3000K | | 3500K | | 4000K | |
| Dimming | 120V Dimming | 0-10V | 120V Dimming | 0-10V | 120V Dimming | 0-10V |
| Output | 15.9W | 16.2W | 16.5W | 15.2W | 16.1W | 15.4W |
| Lumens | 1,278 | 1,206 | 1,314 | 1,277 | 1,333 | 1,285 |
| LPW | 80 | 75 | 80 | 84 | 83 | 84 |

ACCESSORY ORDERING INFORMATION

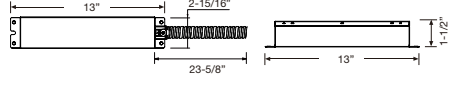
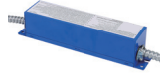
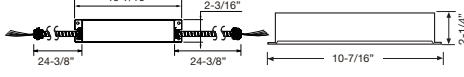
| Product | Model | Description | Pictures | Dimensions |
|---------|---------------|---|--|---|
| 35475 | 3N1/TRM/9/BL | 9" 3N1 - Black Trim |  |  |
| 35476 | 3N1/TRM/9/BZ | 9" 3N1 - Bronze Trim (Not for use outdoor) |  |  |
| 35477 | 3N1/TRM/9/BN | 9" 3N1 - Brushed Nickel Trim (Not for use outdoor) |  |  |
| 35479 | 3N1/ACC/56CAN | 5-6" Can Installation Accessories |  |  |
| 35480 | 3N1/ACC/JBOX | Direct Mount Accessory J-Box |  |  |
| 37934 | 8EMINVERTER | California Title 20 Compliant 8W Emergency LED Inverter (Field Installation) Not compatible with 120V dimming models |  |  |
| 37935 | 21EMINVERTER | California Title 20 Compliant 21W Emergency LED Inverter (Field Installation) |  |  |
| 98003 | 23EMDRIVER | California Title 20 Compliant 23W Emergency LED Driver (Field Installation) |  |  |

ORDERING GUIDE

| Product | Model |
|---------|-------------------------|
| 35464 | 3N1/9/90/CCTS/DIM120V |
| 35468 | 3N1/9/90/CCTS/DIM010UNV |

Note: All rights reserved. All sizes and specifications are subject to change at any time without notice.