

Project Name:	Type:
Part Number:	Date:



GREENCREATIVE

SPECFIT NEW CONSTRUCTION 6"

SPECIFICATION FEATURES

- Mechanical** - Galvanized steel plaster frame. Low profile bar hangers with non-pass through construction and leveling flanges contain integral tee bar clip and preinstalled nail. Bar hangers are adjustable from 13-1/4" to 24-1/2" and can be installed in suspended T-Grid or wood joist ceilings. Attached junction box with quick connect MC cable allows for easy fixture wiring. The reflector's spring action clips allow for a secure installation in ceilings from 1/2" to 2" thick.
- Electrical** - Two selectable lumen output driver options with SelectDrive technology. The 120V, 50/60 Hz driver is forward or reverse phase dimmable to 5%. The 120-277V, 50/60 Hz driver is 0-10V dimmable to 5% with a low end cutoff and comes with a 12V auxiliary port that provides power for field installed sensors and control modules. Additional DualDim driver is also available, with 0-10V dimming down to 1% at 120-277V and Forward/Reverse phase dimming at 120V only. Static lumen output driver options include the Lutron Hi-Lume 1% EcoSystem driver with Soft-On, Fade-to-Black which dims to 1%. EldoLED ECOdrive and SOLOdrive drivers are available in 0-10V and DALi configurations and dim smoothly to 1% and 0.1% respectively.
- Optical** - Self-flanged plated polycarbonate reflector. 40° optical cutoff. Field interchangeable optical lenses. Five beam distributions range from 15° to 75°. Wall wash field installed accessory. COB LED binned to 3-step SDCM to ensure color uniformity in 2700K, 3000K, 3500K, 4000K or 5000K CCT. Minimum 90 CRI. 97 CRI with TRUE CHROMA available in 3000K only.
- Thermal** - Die cast heat sink. L70 lifetime of 100,000 hours. Fixture operating temperature: -13°F to +95°F (-25°C to 35°C).
- Compliance and Warranty** - ETL Classified and Listed for damp locations. ETL Classified for WET location, under covered ceiling, when utilizing WET option with field installed gasketed ring. Suitable for exterior under canopy mounting when utilizing OUT Outdoor Debris Ingress Protection option. 5 year parts warranty for complete fixture. Optional 10 Year Extended Warranty available, subject to same terms, conditions and installation requirements as standard 5 Year Warranty. BAA Compliant Option Available.



SCAN ME
or Click Here

DIGITAL NAVIGATION Explore the spec sheet through the links below

- | | |
|---------------------------------------|---|
| ORDERING GUIDE | NUROAIR CONTROLS ORDERING GUIDE |
| TECHNICAL INFORMATION | NOMINAL PERFORMANCE |
| LINE DRAWINGS | ACCESSORY ORDERING INFORMATION |
| PHOTOMETRY | EXTENDED WARRANTY |



BENEFITS

- Get the right amount of light with SelectDrive technology
- Fits standard 2x2 & 2x4 T-Grids and up to 24" wood joist spacing
- 42° optical cutoff reduces glare and make the space more comfortable
- Multiple reflector finish options facilitate any décor
- Field interchangeable optics ensure smooth light levels
- Large variety of dimming and sensor control options
- Exceptional color rendering and uniformity

SUITABLE APPLICATIONS

- | | | |
|--|---|--|
| <ul style="list-style-type: none"> Commercial Office Hospitality | <ul style="list-style-type: none"> Retail Educational | <ul style="list-style-type: none"> Healthcare Exterior Under Canopy* |
|--|---|--|

*Applicable with OUT Outdoor Debris Ingress Protection option.



SPECFIT NEW CONSTRUCTION 6"

ORDERING GUIDE

SelectDrive Light Engine and Reflector (A complete fixture consists of one light engine and one reflector)

Light Engine PART#

Example: SPFTR6LEL9035KDIM010UNVMDOUTEM

Frame Housing	Light Engine	CRI	CCT	Driver	Optical Distribution	Options ⁵
SPFTR6 SPECFIT Round New Construction 6"	LES Small Light Engine 500-700-1000 lumens	90 CRI 90+	27 2700K	KDIM010UNV² K-case Driver, SelectDrive 120-277V, 50/60Hz. Dimmable to 5%.	SP⁷ Spot 15° Beam Angle	BLANK None
	SPFTS6 SPECFIT Square New Construction 6"	LEM Medium Light Engine 1500-2000-2500 lumens	97³ 97 CRI 3000K only TRUE CHROMA	30 3000K	KDIM120V SelectDrive 120V, 50/60Hz Forward/Reverse Phase dimming. Dimmable to 10%.	MD¹ Medium (Installed Standard) 60° Beam Angle
	LEL Large Light Engine 3000-4000-5000 lumens		35 3500K	DUALDIM1 0-10V dimming to 1% at 120-277V, and Forward/Reverse phase dimming at 120V only.	VN Very Narrow 25° Beam Angle	EM⁴ 10.7W Title 20 Compliant Emergency Backup
			40 4000K		NR Narrow 40° Beam Angle	AWN¹⁰ Lutron Athena Node
			50 5000K		WD Wide 75° Beam Angle	OUT Outdoor Debris Ingress Protection
						WET⁶ Field installable wet location gasketed ring
						NURO/RCM⁹ NUROAir Ready Power Pack for Ceiling Mount Sensor

Reflector PART#

Example: ADR6CC

Shape	Finish	BAA Option
ADR6 6" Round Reflector	CC Clear Diffuse Trim and Flange	BAA¹² Buy American Act Compliant
ADS6¹¹ 6" Square Reflector	WH Matte White Trim and Flange	
	CW Clear Diffuse Trim, White Flange	
	BL Matte Black Trim and Flange	
	CZ⁸ Customized Trim and Flange	

- FOOTNOTES:
- Medium Lens Optic comes installed as standard, if other optic distribution selected the lens will ship separately and require field installation.
 - Dims to 5% with low end cutoff. Dimmer compatibility available on website.
 - CRI97 TRUE CHROMA is only available in 3000K only and is not Energy Star rated. It is made to order (MTO) for the lumen values of 3000 and above, including the LEL light engine.
 - EM cannot be combined with SD347 or SD480 option.
 - Options are factory installed and come with the Light Engine and Driver.
 - Wet location makes the downlight ETL certified for WET location installation, separate gasketed ring will be provided with the light engine for field installation. WET location is not compatible with any sensor options.
 - SP optic is not available with LEL model.
 - Please contact factory for customized finish color or customized reflectors for feasibility and lead times.
 - This option needs to be selected for each fixture to use with NURO7/CM.
 - Only available with KDIM010UNV, using 12V Aux.
 - Square reflector is not available with CW or BL finish as standard options.
 - For BAA option all the parts are assembled together in our factory including the reflector and the light engine, also please put the reflector and the Light Engines together in the same reference when ordering BAA option, ex: SPFTR6LEM9035 KDIM010UNVMDADR6CCBAA.



SPECFIT NEW CONSTRUCTION 6"

Fixed Output Light Engine and Reflector (A complete fixture consists of one light engine and one reflector)

Light Engine PART#

Example: SPFTR6LE209035ELD-S010UNVWD

Frame Housing	Light Engine	CRI	CCT	Driver	Optical Distribution	Options ⁴
SPFTR6 SPECFIT Round New Construction 6" SPFTR6 SPECFIT Square New Construction 6"	LE05 500 lumens	90 CRI 90+	27 2700K	DUALDIM1 0-10V dimming to 1% at 120-277V, and Forward/Reverse phase dimming at 120V only.	SP⁷ Spot 15° Beam Angle	BLANK None
	LE07 700 lumens	97² 97 CRI 3000K only TRUE CHROMA	30 3000K	XT010UNV Signify 0-10V Driver 1% Dimming, 120-277V	MD¹ Medium (Installed Standard) 60° Beam Angle	SD347 347V - 240V Step Down Transformer
	LE10 1,000 lumens		35 3500K	LUT-1UNV Lutron EcoSystem 1% Dimming, 120-277V	VN Very Narrow 25° Beam Angle	EM³ 10.7W Title 20 Compliant Emergency Backup
	LE15 1,500 lumens		40 4000K	LUT-L3DUNV Lutron Hi-Lume 3-Wire 1% Dimming, 120-277V	NR Narrow 40° Beam Angle	OUT Outdoor Debris Ingress Protection
	LE20 2,000 lumens		50 5000K	ELD-E010UNV EldoLED ECOdrive 0-10V 1%, 120-277V	WD Wide 75° Beam Angle	WET⁶ Field installable wet location gasketed ring
	LE25 2,500 lumens		ELD-EDALIUNV EldoLED ECOdrive DALI 1%, 120-277V	ELD-S010UNV EldoLED SOLOdrive 0-10V 0.1%, 120-277V		
	LE30 3,000 lumens		ELD-SDALIUNV EldoLED SOLOdrive DALI 0.1%, 120-277V			
	LE40 4,000 lumens					
LE50⁵ 5,000 lumens						

Reflector PART#

Example: ADR6CC

Shape	Finish	BAA Option
ADR6 6" Round Reflector ADS6⁹ 6" Square Reflector	CC Clear Diffuse Trim and Flange WH Matte White Trim and Flange CW Clear Diffuse Trim, White Flange BL Matte Black Trim and Flange CZ⁸ Customized Trim and Flange	BAA¹⁰ Buy American Act Compliant

FOOTNOTES:

- Medium Lens Optic comes installed as standard, if other optic distribution selected the lens will ship separately and require field installation.
- CRI97 TRUE CHROMA is only available in 3000K only and is not Energy Star rated. It is made to order (MTO) for the lumen values of 3000 and above, including the LEL light engine.
- EM cannot be combined with SD347 or SD480 option.
- Options are factory installed and come with the Light Engine and Driver.
- LE50 is not available with LUT-1UNV and LUT-L3DUNV.
- Wet location makes the downlight ETL certified for WET location installation, separate gasketed ring will be provided with the light engine for field installation. WET location is not compatible with any sensor options.
- SP optic is not available with LEL model.
- Please contact factory for customized finish color or customized reflectors for feasibility and lead times.
- Square reflector is not available with CW or BL finish as standard options.
- For BAA option all the parts are assembled together in our factory including the reflector and the light engine, also please put the reflector and the Light Engines together in the same reference when ordering BAA option.



SPECFIT NEW CONSTRUCTION 6"

NUROAir CONTROLS ORDERING GUIDE

Control	Switches
NURO7/CM¹ NUROAir Bluetooth Ceiling Mount Dual Mode Sensor	NURO-SW-3B-BA-BL-WP-V1 NUROAir 3-Button Bluetooth Battery Powered Wall Switch
	NURO-SW-5B-BA-BL-WP-V1 NUROAir 5-Button Bluetooth Battery Powered Wall Switch
	NURO-SW-7B-AC-BL-WP-V1 NUROAir 7-Button Bluetooth Line Voltage (AC 120-277V) Powered Wall Switch

FOOTNOTES: 1. 600 sq ft sensor coverage

NUROAir by ILLUMUS

NUROAir Bluetooth Ceiling Mount Dual Mode Sensor is the optimal groupable controls lighting solution. With main features such as PIR Motion and Ultrasonic Sensing, Occupancy/Vacancy, and Bi-Level Dimming - this flexibility makes the NUROAir Bluetooth Ceiling Mount Dual Mode Sensor ideal for tailoring lighting to specific space needs, optimizing both ambiance and efficiency. The NUROAir App, available for download on iOS and Google Play Store, offers a user-friendly interface for automatic or manual customization of your space. Through the app, users can configure sensor settings such as the Light Output, CCT, Hold Time, Standby Time/Level, High/Low End Trim, Background Light Level, Set Schedules, and Control Lighting Groups or Zones, all from a mobile or tablet device. Manual control is also available with a range of compatible wireless & wired wall switch options.



Click Here or Scan Code
to Learn More About
NUROAir Bluetooth Controls

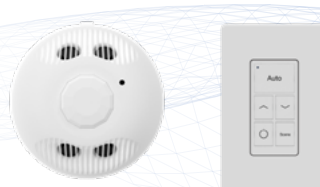

TECHNICAL INFORMATION

Light Engine	Input Voltage	Input Frequency	Input Current	Input Power	THD Power	Power Factor
LESXXXX	120 / 277V	50 / 60Hz	0.115 / 0.047A	13W	<20%	>0.9
LEMXXXX	120 / 277V	50 / 60Hz	0.270 / 0.114A	31.5W	<20%	>0.9
LELXXXX	120 / 277V	50 / 60Hz	0.530 / 0.217A	60W	<20%	>0.9
LE05XXXX	120 / 277V	50 / 60Hz	0.056 / 0.024A	6.5W	<20%	>0.9
LE07XXXX	120 / 277V	50 / 60Hz	0.073 / 0.034A	8.5W	<20%	>0.9
LE10XXXX	120 / 277V	50 / 60Hz	0.112 / 0.047A	13W	<20%	>0.9
LE15XXXX	120 / 277V	50 / 60Hz	0.154 / 0.068A	18W	<20%	>0.9
LE20XXXX	120 / 277V	50 / 60Hz	0.218 / 0.092A	25.5W	<20%	>0.9
LE25XXXX	120 / 277V	50 / 60Hz	0.269 / 0.116A	31.5W	<20%	>0.9
LE30XXXX	120 / 277V	50 / 60Hz	0.318 / 0.133A	37.5W	<20%	>0.9
LE40XXXX	120 / 277V	50 / 60Hz	0.411 / 0.165A	48.5W	<20%	>0.9
LE50XXXX	120 / 277V	50 / 60Hz	0.487 / 0.203A	57.5W	<20%	>0.9

Note: All rights reserved. All sizes and specifications are subject to change at any time without notice.



SPECFIT NEW CONSTRUCTION 6"

NOMINAL PERFORMANCE

LES (LE05 / LE07 / LE10) - Low / Medium / High - 6.5 / 8.5 / 12.5W

CCT	2700K						3000K						3500K						4000K						5000K					
	Low		Medium		High		Low		Medium		High		Low		Medium		High		Low		Medium		High		Low		Medium		High	
	Im	LPW	Im	LPW	Im	LPW	Im	LPW	Im	LPW	Im	LPW	Im	LPW	Im	LPW	Im	LPW	Im	LPW	Im	LPW	Im	LPW	Im	LPW	Im	LPW	Im	LPW
Clear Diffuse	500	77	700	82	1,000	80	525	81	735	86	1,050	84	550	85	770	91	1,100	88	575	88	805	95	1,150	92	580	89	810	95	1,165	93
White	495	76	693	82	990	79	520	80	728	86	1,040	83	545	84	762	90	1,089	87	569	88	797	94	1,139	91	574	88	802	94	1,153	92
Black	440	68	616	72	880	70	462	71	647	76	924	74	484	74	678	80	968	77	506	78	708	83	1,012	81	510	78	714	84	1,015	81

LEM (LE15 / LE20 / LE25) - Low / Medium / High - 18.0 / 25.5 / 31.5W

CCT	2700K						3000K						3500K						4000K						5000K					
	Low		Medium		High		Low		Medium		High		Low		Medium		High		Low		Medium		High		Low		Medium		High	
	Im	LPW	Im	LPW	Im	LPW	Im	LPW	Im	LPW	Im	LPW	Im	LPW	Im	LPW	Im	LPW	Im	LPW	Im	LPW	Im	LPW	Im	LPW	Im	LPW	Im	LPW
Clear Diffuse	1,600	89	2,125	83	2,500	79	1,632	91	2,169	85	2,550	81	1,664	92	2,210	87	2,600	83	1,696	94	2,253	88	2,650	84	1,713	95	2,275	89	2,677	85
White	1,584	88	2,104	82	2,475	78	1,616	90	2,147	84	2,525	80	1,647	91	2,188	86	2,574	82	1,679	93	2,230	87	2,624	83	1,696	94	2,252	88	2,650	84
Black	1,408	78	1,870	73	2,200	70	1,436	80	1,909	75	2,244	71	1,464	81	1,945	77	2,288	73	1,492	83	1,983	77	2,332	74	1,507	84	2,002	79	2,355	75

LEL (LE30 / LE40 / LE50) - Low / Medium / High - 37.5 / 48.5 / 60.0W

CCT	2700K						3000K						3500K						4000K						5000K					
	Low		Medium		High		Low		Medium		High		Low		Medium		High		Low		Medium		High		Low		Medium		High	
	Im	LPW	Im	LPW	Im	LPW	Im	LPW	Im	LPW	Im	LPW	Im	LPW	Im	LPW	Im	LPW	Im	LPW	Im	LPW	Im	LPW	Im	LPW	Im	LPW	Im	LPW
Clear Diffuse	3,325	89	4,085	84	4,750	79	3,360	90	4,080	84	4,800	80	3,500	93	4,250	88	5,000	83	3,640	97	4,420	91	5,200	87	3,640	97	4,420	91	5,200	87
White	3,292	88	4,044	83	4,703	78	3,326	89	4,039	83	4,752	79	3,465	92	4,208	87	4,950	82	3,604	96	4,376	90	5,148	86	3,604	96	4,376	90	5,148	86
Black	2,826	78	3,472	71	4,038	67	2,856	77	3,468	71	4,080	68	2,975	79	3,613	75	4,250	71	3,094	82	3,757	77	4,420	74	2,829	75	3,757	77	4,420	74

FOOTNOTES: ** Lumen output are based on rated lumens, for exact value please refer to the IES files



SPECFIT NEW CONSTRUCTION 6"

LINE DRAWINGS

Round

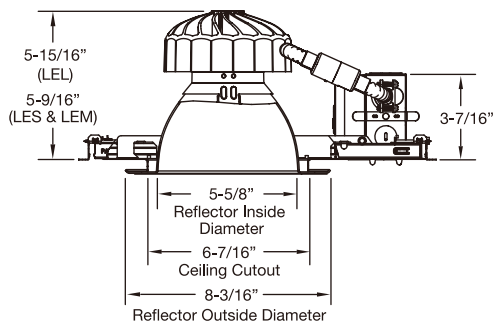

Square

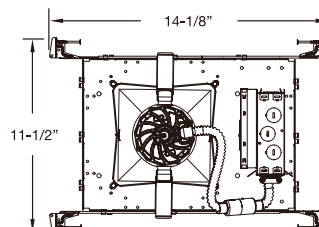
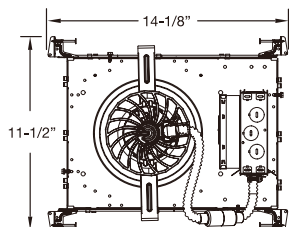
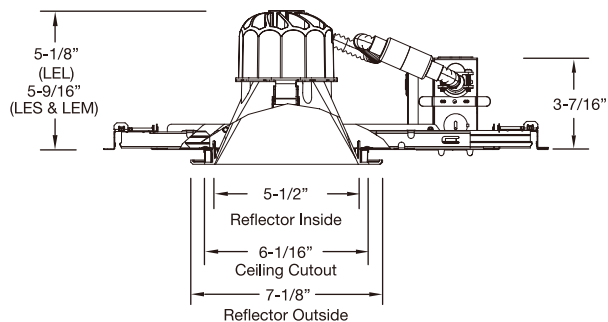

with / EM

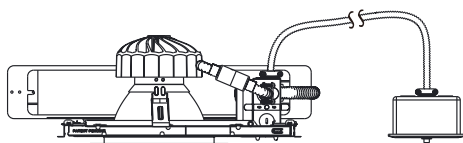

EM Test Switch shown.
Single gang j-box by others.

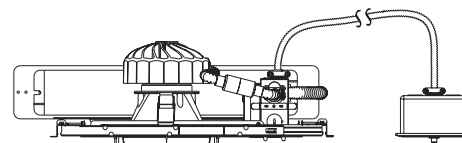



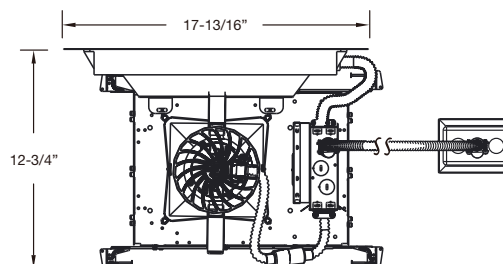
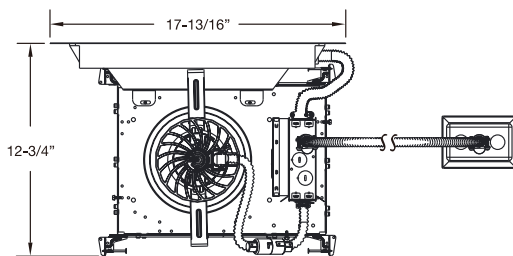





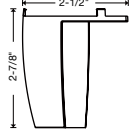

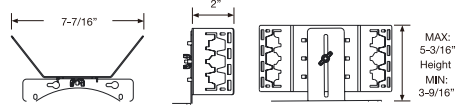

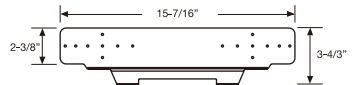
EM Test Switch shown.
Single gang j-box by others.

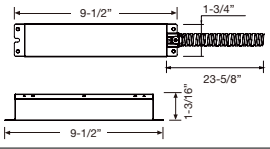

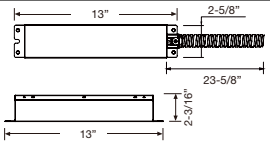

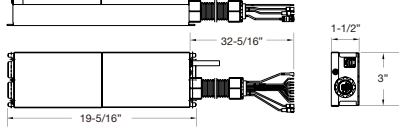
SPECFIT NEW CONSTRUCTION 6"

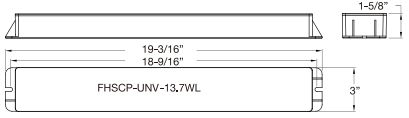
ACCESSORY ORDERING INFORMATION				
Product	Model	Description	Pictures	Dimensions
98079	ADWAW	Wall Wash (Field Installed on Module)		
35126	NCFBFB	Field Installable Butterfly Brackets (pair of 2) For New Construction Frame		
35125 ¹	NCFEMB ¹	Field Installable Brackets For emergency Driver or Inverter with New Construction Frame		
37934	8EMINVERTER	California Title 20 Compliant 8W Emergency LED Inverter (Field Installation) Compatible for 0-10V dimming models		
38096	24EMINVERTER	California Title 20 Compliant 24W Emergency LED Inverter (Field Installation) Compatible for 0-10V dimming models		
FHUPS1-UNV-25L-SD	FHUPS1-UNV-25L-SD	25W Emergency Micro Inverter for field installation to use with 0-10V Driver options. 100-277VAC (up to 150W with use of 0-10V dimming). CEC Compliant		
FHSCP-UNV-10.7WL	FHSCP-UNV-10.7WL	10.7W Emergency Driver for field installation to use with 120V and 0-10V driver options. CEC Compliant		

FOOTNOTES:

- 1. Only needed for field installable emergency driver/inverter

Note: For details of compatibility between each emergency solution and specific product models, please refer to the Products Emergency Compatibility Matrix file available on <https://greencreative.com/emergency-accessories/>

Note: All rights reserved. All sizes and specifications are subject to change at any time without notice.



SPECFIT NEW CONSTRUCTION 6"

PHOTOMETRY

SPFTR6-LES9035-KDIM010-UNV-VN-ADR6CC

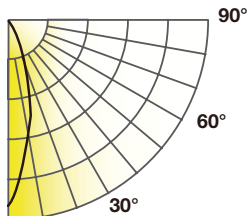

Lumens: 1,236 lm
Power: 12.7 W
Efficacy: 98 lm/W
CRI: 90+
Spacing Criteria: 0.4
Beam Angle: 25°

Candlepower Distribution	
Angle (°)	Average (cd)
10	2,603
20	1,157
30	293
40	40
50	6
60	2
70	1
80	0
90	0

Initial Footcandles		
Height (ft)	Fc	Diameter (ft)
4	278	2
6	123	3
8	69	4
10	44	5
12	31	5

Zonal Lumen Summary		
Zone	Lumens	%Fixt
0-30	1,139	93
0-40	1,214	98
0-60	1,234	100
0-90	1,236	100

SPFTR6-LES9035-KDIM010-UNV-VN-ADS6CC

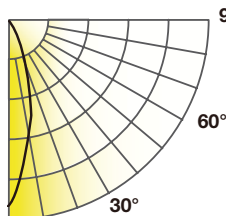

Lumens: 1,220 lm
CBCP: 4,292 cd
Power: 11 W
Efficacy: 98 lm/W
CRI: 90+
Spacing Criteria: 0.42
Beam Angle: 26°

Candlepower Distribution	
Angle (°)	Average (cd)
10	2,545
20	1,189
30	316
40	66
50	12
60	0
70	0
80	0
90	0

Initial Footcandles		
Height (ft)	Fc	Diameter (ft)
4	236	1.8
6	105	2.7
8	59	3.6
10	38	4.5
12	26	5.4

Zonal Lumen Summary		
Zone	Lumens	%Fixt
0-30	1,094	90
0-40	1,192	98
0-60	1,219	100
0-90	1,219	100

SPFTR6-LES9035-KDIM010-UNV-NR-ADR6CC

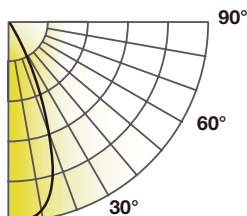

Lumens: 1,234 lm
Power: 12.5 W
Efficacy: 99 lm/W
CRI: 90+
Spacing Criteria: 0.7
Beam Angle: 43°

Candlepower Distribution	
Angle (°)	Average (cd)
10	2,233
20	1,401
30	456
40	46
50	5
60	2
70	1
80	0
90	0

Initial Footcandles		
Height (ft)	Fc	Diameter (ft)
4	141	3
6	63	5
8	35	6
10	23	8
12	16	9

Zonal Lumen Summary		
Zone	Lumens	%Fixt
0-30	1,111	93
0-40	1,217	98
0-60	1,233	100
0-90	1,234	100

SPFTR6-LES9035-KDIM010-UNV-NR-ADS6CC

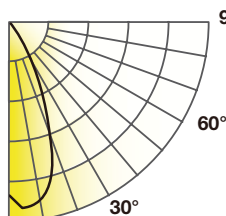

Lumens: 1,240 lm
CBCP: 2,379 cd
Power: 11 W
Efficacy: 100 lm/W
CRI: 90+
Spacing Criteria: 0.67
Beam Angle: 43°

Candlepower Distribution	
Angle (°)	Average (cd)
10	2,206
20	1,371
30	444
40	72
50	12
60	0
70	0
80	0
90	0

Initial Footcandles		
Height (ft)	Fc	Diameter (ft)
4	205	3.1
6	91	4.7
8	51	6.2
10	33	7.8
12	23	9.4

Zonal Lumen Summary		
Zone	Lumens	%Fixt
0-30	1,084	87
0-40	1,216	98
0-60	1,239	100
0-90	1,239	100

SPFTR6-LES9035-KDIM010-UNV-MD-ADR6CC

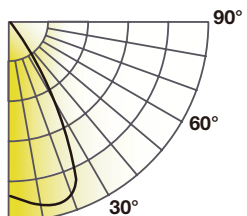

Lumens: 1,240 lm
Power: 12.2 W
Efficacy: 102 lm/W
CRI: 90+
Spacing Criteria: 0.9
Beam Angle: 64°

Candlepower Distribution	
Angle (°)	Average (cd)
10	1,317
20	1,277
30	755
40	168
50	8
60	2
70	1
80	0
90	0

Initial Footcandles		
Height (ft)	Fc	Diameter (ft)
8	80	4
10	36	7
12	20	9
15	13	11
20	9	13

Zonal Lumen Summary		
Zone	Lumens	%Fixt
0-30	965	74
0-40	1,203	95
0-60	1,237	100
0-90	1,240	100

SPFTR6-LES9035-KDIM010-UNV-MD-ADS6CC

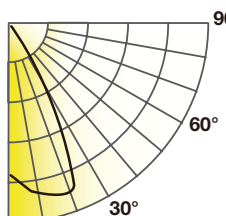

Lumens: 1,257 lm
CBCP: 1,396 cd
Power: 11 W
Efficacy: 101 lm/W
CRI: 90+
Spacing Criteria: 0.90
Beam Angle: 64°

Candlepower Distribution	
Angle (°)	Average (cd)
10	1,308
20	1,250
30	696
40	169
50	20
60	1
70	0
80	0
90	0

Initial Footcandles		
Height (ft)	Fc	Diameter (ft)
4	121	5.0
6	54	7.5
8	30	10.0
10	19	12.4
12	13	14.9

Zonal Lumen Summary		
Zone	Lumens	%Fixt
0-30	952	76
0-40	1,201	96
0-60	1,256	100
0-90	1,256	100



SPECFIT NEW CONSTRUCTION 6"

PHOTOMETRY

SPFTR6-LES9035-KDIM010-UNV-WD-ADR6CC

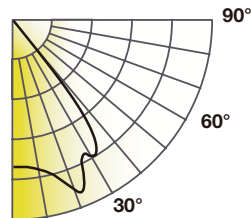

Candlepower Distribution	
Angle (°)	Average (cd)
10	1,153
20	1,238
30	704
40	137
50	26
60	6
70	2
80	0
90	0

Initial Footcandles		
Height (ft)	Fc	Diameter (ft)
4	56	6
6	25	9
8	14	13
10	9	16
12	6	19

Zonal Lumen Summary		
Zone	Lumens	%Fixt
0-30	663	53
0-40	1,120	89
0-60	1,251	100
0-90	1,257	100

Lumens: 1,257 lm
 Power: 12.28 W
 Efficacy: 102.33 lm/W
 CRI: 90+
 Spacing Criteria: 1.2
 Beam Angle: 76.9°

SPFTR6-LES9035-KDIM010-UNV-WD-ADS6CC

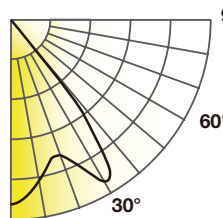

Candlepower Distribution	
Angle (°)	Average (cd)
10	755
20	706
30	846
40	467
50	76
60	1
70	0
80	0
90	0

Initial Footcandles		
Height (ft)	Fc	Diameter (ft)
4	70	6.8
6	31	10.2
8	18	13.6
10	11	17.1
12	8	20.5

Zonal Lumen Summary		
Zone	Lumens	%Fixt
0-30	642	51
0-40	1,080	86
0-60	1,250	100
0-90	1,250	100

Lumens: 1,250 lm
 CBCP: 900 cd
 Power: 11 W
 Efficacy: 101 lm/W
 CRI: 90+
 Spacing Criteria: 1.22
 Beam Angle: 81°

SPFTR6-LEM9035-KDIM010-UNV-VN-ADR6CC

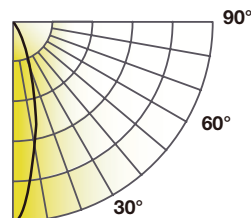

Candlepower Distribution	
Angle (°)	Average (cd)
10	5,592
20	2,178
30	635
40	88
50	12
60	4
70	1
80	0
90	0

Initial Footcandles		
Height (ft)	Fc	Diameter (ft)
4	607	2
6	270	3
8	152	3
10	97	4
12	67	5

Zonal Lumen Summary		
Zone	Lumens	%Fixt
0-30	2,364	93
0-40	2,510	98
0-60	2,539	100
0-90	2,555	100

Lumens: 2,555 lm
 Power: 30.9 W
 Efficacy: 83 lm/W
 CRI: 90+
 Spacing Criteria: 0.4
 Beam Angle: 25°

SPFTR6-LEM9035-KDIM010-UNV-VN-ADS6CC

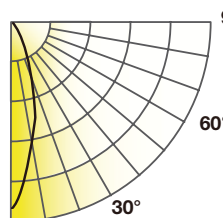

Candlepower Distribution	
Angle (°)	Average (cd)
10	5,323
20	2,507
30	698
40	144
50	30
60	1
70	0
80	0
90	0

Initial Footcandles		
Height (ft)	Fc	Diameter (ft)
4	495	1.8
6	220	2.8
8	124	3.7
10	79	4.6
12	55	5.5

Zonal Lumen Summary		
Zone	Lumens	%Fixt
0-30	2,340	90
0-40	2,552	98
0-60	2,610	100
0-90	2,611	100

Lumens: 2,613 lm
 CBCP: 9,216 cd
 Power: 28 W
 Efficacy: 81 lm/W
 CRI: 90+
 Spacing Criteria: 0.42
 Beam Angle: 26°

SPFTR6-LEM9035-KDIM010-UNV-NR-ADR6CC

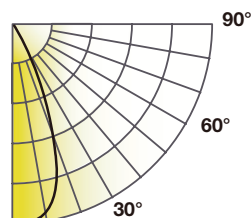

Candlepower Distribution	
Angle (°)	Average (cd)
10	4,978
20	2,529
30	920
40	86
50	11
60	3
70	1
80	0
90	0

Initial Footcandles		
Height (ft)	Fc	Diameter (ft)
4	302	3
6	134	5
8	76	6
10	48	7
12	34	9

Zonal Lumen Summary		
Zone	Lumens	%Fixt
0-30	2,332	91
0-40	2,532	99
0-60	2,562	100
0-90	2,567	100

Lumens: 2,567 lm
 Power: 31.1 W
 Efficacy: 83 lm/W
 CRI: 90+
 Spacing Criteria: 0.7
 Beam Angle: 41°

SPFTR6-LEM9035-KDIM010-UNV-NR-ADS6CC

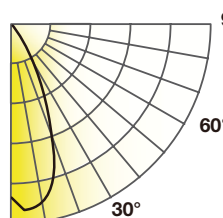

Candlepower Distribution	
Angle (°)	Average (cd)
10	4,951
20	2,936
30	968
40	151
50	14
60	1
70	0
80	0
90	0

Initial Footcandles		
Height (ft)	Fc	Diameter (ft)
4	460	3.0
6	204	4.5
8	115	6.0
10	74	7.5
12	51	9.0

Zonal Lumen Summary		
Zone	Lumens	%Fixt
0-30	2,357	89
0-40	2,617	98
0-60	2,661	100
0-90	2,661	100

Lumens: 2,153 lm
 CBCP: 1,658 cd
 Power: 20 W
 Efficacy: 106 lm/W
 CRI: 90+
 Spacing Criteria: 0.98
 Beam Angle: 68°



SPECFIT NEW CONSTRUCTION 6"

PHOTOMETRY

SPFTR6-LEM9035-KDIM010-UNV-MD-ADR6CC

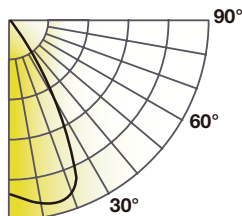

Lumens: 2,532 lm
Power: 30.9 W
Efficacy: 82 lm/W
CRI: 90+
Spacing Criteria: 0.9
Beam Angle: 65°

Candlepower Distribution	
Angle (°)	Average (cd)
10	2,493
20	2,839
30	1,555
40	232
50	13
60	4
70	2
80	0
90	0

Initial Footcandles		
Height (ft)	Fc	Diameter (ft)
4	164	4
6	73	6
8	41	8
10	26	11
12	18	13

Zonal Lumen Summary		
Zone	Lumens	%Fixt
0-30	1,957	77
0-40	2,460	97
0-60	2,526	100
0-90	2,532	100

SPFTS6-LEM9035-KDIM010-UNV-MD-ADS6CC

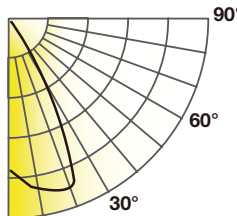

Lumens: 2,680 lm
CBCP: 2,976 cd
Power: 28 W
Efficacy: 81 lm/W
CRI: 90+
Spacing Criteria: 0.91
Beam Angle: 64°

Candlepower Distribution	
Angle (°)	Average (cd)
10	2,802
20	2,655
30	1,539
40	395
50	20
60	2
70	0
80	0
90	0

Initial Footcandles		
Height (ft)	Fc	Diameter (ft)
4	260	5.0
6	116	7.5
8	65	10.0
10	42	12.5
12	29	15.0

Zonal Lumen Summary		
Zone	Lumens	%Fixt
0-30	2,025	76
0-40	2,555	95
0-60	2,677	100
0-90	2,678	100

SPFTR6-LEM9035-KDIM010-UNV-WD-ADR6CC

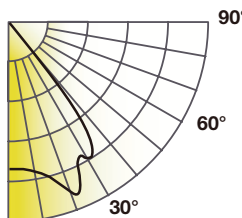

Lumens: 2,555 lm
Power: 31.0 W
Efficacy: 82 lm/W
CRI: 90+
Spacing Criteria: 1.2
Beam Angle: 83°

Candlepower Distribution	
Angle (°)	Average (cd)
10	1,508
20	1,366
30	2,064
40	1,066
50	45
60	13
70	5
80	2
90	0

Initial Footcandles		
Height (ft)	Fc	Diameter (ft)
4	113	6
6	50	9
8	28	13
10	18	16
12	13	19

Zonal Lumen Summary		
Zone	Lumens	%Fixt
0-30	1,289	50
0-40	2,261	89
0-60	2,543	100
0-90	2,555	100

SPFTS6-LEM9035-KDIM010-UNV-WD-ADS6CC

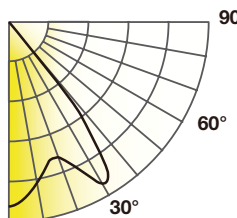

Lumens: 2,684 lm
CBCP: 1,900 cd
Power: 28 W
Efficacy: 83 lm/W
CRI: 90+
Spacing Criteria: 1.19
Beam Angle: 81°

Candlepower Distribution	
Angle (°)	Average (cd)
10	1,626
20	1,521
30	1,826
40	1,037
50	155
60	3
70	0
80	0
90	0

Initial Footcandles		
Height (ft)	Fc	Diameter (ft)
4	151	6.9
6	67	10.3
8	38	13.7
10	24	17.1
12	17	20.6

Zonal Lumen Summary		
Zone	Lumens	%Fixt
0-30	1,378	51
0-40	2,318	86
0-60	2,681	100
0-90	2,683	100

SPFTR6-LEL9035-KDIM010-UNV-VN-ADR6CC

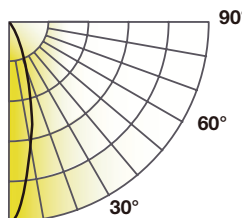

Lumens: 4,709 lm
Power: 60.7 W
Efficacy: 78 lm/W
CRI: 90+
Spacing Criteria: 0.5
Beam Angle: 33°

Candlepower Distribution	
Angle (°)	Average (cd)
10	813
20	478
30	204
40	26
50	5
60	2
70	1
80	0
90	0

Initial Footcandles		
Height (ft)	Fc	Diameter (ft)
8	176	5
10	113	6
12	78	7
15	50	9
20	28	12

Zonal Lumen Summary		
Zone	Lumens	%Fixt
0-30	4,118	88
0-40	4,566	97
0-60	4,687	100
0-90	4,709	100

SPFTR6-LEL9035-KDIM010-UNV-VN-ADS6CC

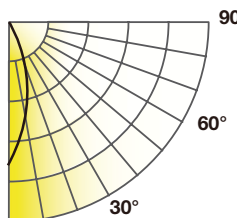

Lumens: 4,765 lm
CBCP: 10,381 cd
Power: 28 W
Efficacy: 79 lm/W
CRI: 90+
Spacing Criteria: 0.55
Beam Angle: 34°

Candlepower Distribution	
Angle (°)	Average (cd)
10	1,626
20	1,521
30	1,826
40	1,037
50	155
60	3
70	0
80	0
90	0

Initial Footcandles		
Height (ft)	Fc	Diameter (ft)
4	151	2.4
6	67	3.7
8	38	4.9
10	24	6.1
12	17	7.3

Zonal Lumen Summary		
Zone	Lumens	%Fixt
0-30	1,378	51
0-40	2,318	86
0-60	2,681	100
0-90	2,683	100



SPECFIT NEW CONSTRUCTION 6"

PHOTOMETRY

SPFTR6-LEL9035-KDIM010-UNV-NR-ADR6CC

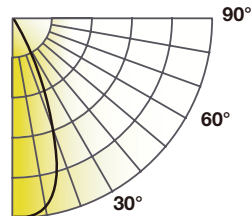

Candlepower Distribution	
Angle (°)	Average (cd)
10	7,615
20	5,149
30	2,134
40	223
50	33
60	11
70	5
80	2
90	0

Initial Footcandles		
Height (ft)	Fc	Diameter (ft)
4	145	7
6	93	8
8	64	10
10	41	12
12	23	16

Zonal Lumen Summary		
Zone	Lumens	%Fixt
0-30	4,182	86
0-40	4,780	98
0-60	4,858	100
0-90	4,874	100

Lumens: 4,874 lm
 Power: 61.1 W
 Efficacy: 80 lm/W
 CRI: 90+
 Spacing Criteria: 0.7
 Beam Angle: 44°

SPFTR6-LEL9035-KDIM010-UNV-NR-ADS6CC

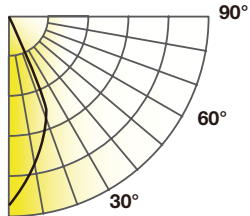

Candlepower Distribution	
Angle (°)	Average (cd)
10	7,593
20	5,198
30	2,044
40	467
50	40
60	5
70	1
80	0
90	0

Initial Footcandles		
Height (ft)	Fc	Diameter (ft)
4	705	3.3
6	313	5.0
8	176	6.6
10	113	8.3
12	78	9.9

Zonal Lumen Summary		
Zone	Lumens	%Fixt
0-30	4,198	83
0-40	4,943	97
0-60	5,071	100
0-90	5,074	100

Lumens: 5,079 lm
 CBCP: 9,154 cd
 Power: 53 W
 Efficacy: 86 lm/W
 CRI: 90+
 Spacing Criteria: 0.68
 Beam Angle: 45°

SPFTR6-LEL9035-KDIM010-UNV-MD-ADR6CC

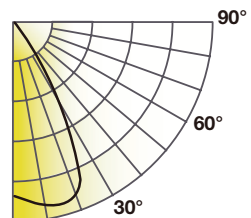

Candlepower Distribution	
Angle (°)	Average (cd)
10	5,967
20	4,373
30	3,080
40	872
50	41
60	13
70	5
80	2
90	0

Initial Footcandles		
Height (ft)	Fc	Diameter (ft)
4	105	8
6	67	10
8	47	12
10	30	15
12	17	20

Zonal Lumen Summary		
Zone	Lumens	%Fixt
0-30	3,691	74
0-40	4,850	97
0-60	5,000	100
0-90	5,017	100

Lumens: 5,017 lm
 Power: 60.59 W
 Efficacy: 82.80 lm/W
 CRI: 90+
 Spacing Criteria: 0.78
 Beam Angle: 54.7°

SPFTR6-LEL9035-KDIM010-UNV-MD-ADS6CC

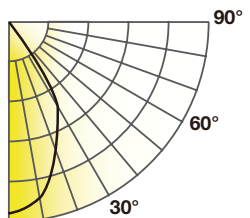

Candlepower Distribution	
Angle (°)	Average (cd)
10	5,593
20	4,188
30	3,109
40	816
50	74
60	6
70	1
80	0
90	0

Initial Footcandles		
Height (ft)	Fc	Diameter (ft)
4	520	3.9
6	231	5.9
8	130	7.9
10	83	9.9
12	58	11.8

Zonal Lumen Summary		
Zone	Lumens	%Fixt
0-30	3,603	71
0-40	4,887	96
0-60	5,104	100
0-90	5,108	100

Lumens: 5,113 lm
 CBCP: 6,346 cd
 Power: 53 W
 Efficacy: 86 lm/W
 CRI: 90+
 Spacing Criteria: 0.80
 Beam Angle: 59°

SPFTR6-LEL9035-KDIM010-UNV-WD-ADR6CC

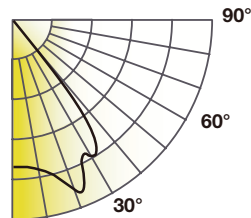

Candlepower Distribution	
Angle (°)	Average (cd)
10	3,860
20	3,786
30	3,355
40	1,658
50	99
60	30
70	12
80	5
90	0

Initial Footcandles		
Height (ft)	Fc	Diameter (ft)
8	63	12
10	40	15
12	28	18
15	18	23
20	10	30

Zonal Lumen Summary		
Zone	Lumens	%Fixt
0-30	3,107	61
0-40	4,612	91
0-60	5,038	99
0-90	5,068	100

Lumens: 5,068 lm
 Power: 60.6 W
 Efficacy: 83 lm/W
 CRI: 90+
 Spacing Criteria: 1.1
 Beam Angle: 81.6°

SPFTR6-LEL9035-KDIM010-UNV-WD-ADS6CC

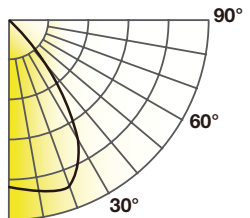

Candlepower Distribution	
Angle (°)	Average (cd)
10	4,015
20	3,849
30	3,108
40	1,581
50	220
60	12
70	3
80	0
90	0

Initial Footcandles		
Height (ft)	Fc	Diameter (ft)
4	373	3.9
6	166	5.9
8	93	7.9
10	60	9.9
12	41	11.8

Zonal Lumen Summary		
Zone	Lumens	%Fixt
0-30	3,152	61
0-40	4,643	89
0-60	5,199	100
0-90	5,207	100

Lumens: 5,212 lm
 CBCP: 4,102 cd
 Power: 53 W
 Efficacy: 88 lm/W
 CRI: 90+
 Spacing Criteria: 1.07
 Beam Angle: 72°



SPECFIT NEW CONSTRUCTION 6"

PHOTOMETRY

SPFTR6-LES9730-KDIM010-UNV-MD-ADR6CC

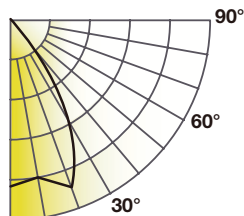

Candlepower Distribution	
Angle (°)	Average (cd)
10	1,012
20	978
30	643
40	172
50	5
60	0
70	0
80	0
90	0

Initial Footcandles		
Height (ft)	Fc	Diameter (ft)
4	94	5
6	42	8
8	24	10
10	15	13
12	10	15

Zonal Lumen Summary		
Zone	Lumens	%Fixt
0-30	761	72
0-40	1,012	95
0-60	1,061	100
0-90	1,061	100



Lumens: 1,061 lm
 Power: 13 W
 Efficacy: 84 lm/W
 CRI: 96
 Spacing Criteria: 1.07
 Beam Angle: 65°

SPFTR6-LEM9730-KDIM010-UNV-MD-ADR6CC

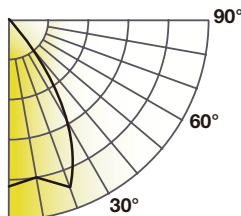

Candlepower Distribution	
Angle (°)	Average (cd)
10	2,129
20	2,057
30	1,357
40	366
50	8
60	2
70	0
80	0
90	0

Initial Footcandles		
Height (ft)	Fc	Diameter (ft)
4	198	5
6	88	8
8	49	10
10	32	13
12	22	15

Zonal Lumen Summary		
Zone	Lumens	%Fixt
0-30	1,595	72
0-40	2,122	95
0-60	2,229	100
0-90	1,160	100



Lumens: 2,231 lm
 Power: 33 W
 Efficacy: 68 lm/W
 CRI: 96
 Spacing Criteria: 1.07
 Beam Angle: 65°

SPFTR6-LEL9730-KDIM010UNV-MD-ADR6CC

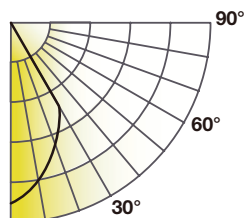

Candlepower Distribution	
Angle (°)	Average (cd)
10	2,129
20	2,057
30	1,357
40	366
50	8
60	2
70	0
80	0
90	0

Initial Footcandles		
Height (ft)	Fc	Diameter (ft)
8	49	9
10	32	11
12	22	13
15	14	16
20	8	22

Zonal Lumen Summary		
Zone	Lumens	%Fixt
0-30	2,963	71
0-40	4,027	95
0-60	4,230	100
0-90	4,230	100



Lumens: 4,230 lm
 Power: 60 W
 Efficacy: 71 lm/W
 CRI: 98
 Spacing Criteria: 0.79
 Beam Angle: 57°

EXTENDED WARRANTY

Model
SPFTR6 / LExx / 10YEARWARRANTY*
SPFTR6 / LE20 / 10YEARWARRANTY*
SPFTR6 / LEMxx / 10YEARWARRANTY*
SPFTR6 / LEM20 / 10YEARWARRANTY*
SPFTR6 / LELxx / 10YEARWARRANTY*
SPFTR6 / LEL20 / 10YEARWARRANTY*

FOOTNOTES:
 *Where xx = Fixture Light Engine lumen output designation.
 Example: 10 Year Warranty Part Number for SPFTR6/LEM or SPFTR6/LE20 Light engine is SPFT6R6/LEM/10YEARWARRANTY and SPFTR6/LE20/10YEARWARRANTY respectively.