

| | |
|---------------|-------|
| Project Name: | Type: |
| Part Number: | Date: |

External Driver PLL

FEATURES

- Replaces 36W / 40W 4-pin (2G11) CFL lamps
- Compatible with GREEN CREATIVE external drivers only
- Flicker Free (percent flicker and flicker index are less than three percent)
- High efficacy up to 157 LPW
- Opaque glass eliminates pixilation and reduces glare
- Plastic film prevents glass from shattering
- Field select from three lumen outputs using SelectDrive driver
- 0-10V dimming* - dims to OFF with SelectDrive driver, dims to 10% with single wattage driver
- Suitable for use in totally enclosed fixtures and damp locations
- Fixture operating temperature: -4°F to 95°F (-20°C to 35°C)
- Lamp ambient temperature: -4°F to 113°F (-20°C to 45°C)
- Rated lifetime (L70): 60,000hrs
- 5 year limited warranty** / 10 year available (see EXTENDED WARRANTIES table for information)
- Each lamp is supplied with one support clip with adhesive back for quick installation



DIGITAL NAVIGATION

Explore the spec sheet through the links below

- [SYSTEM PERFORMANCE](#)
- [DIMENSION & WEIGHT](#)
- [INSTALLATION](#)
- [ACCESSORY ORDERING INFORMATION](#)
- [EXTENDED WARRANTIES](#)
- [LOGISTIC INFORMATION](#)
- [CERTIFICATION INFORMATION](#)

SPECIFICATIONS

| Product | Model | Equiv. | Input Voltage | Wattage | Lumens | CCT | Efficacy (LPW) | Life (hrs) | CRI | Power Factor | THD | Beam Angle | DIM.* | Fixture Rating | DLC | DOE |
|---------|---------------|--------|---------------|---------|--------|-------|----------------|------------|-----|--------------|------|------------|-------|----------------|------|-----|
| 36704 | 13PLL/835/EXT | 36W | 120-277V | 13 | 1,800 | 3500K | 138 | 60,000 | 82 | 0.9 | <20% | 110° | Yes | Enclosed | N.A. | ✓ |
| 36705 | 13PLL/840/EXT | 36W | 120-277V | 13 | 2,000 | 4000K | 154 | 60,000 | 82 | 0.9 | <20% | 110° | Yes | Enclosed | N.A. | ✓ |
| 36707 | 14PLL/835/EXT | 40W | 120-277V | 14 | 2,000 | 3500K | 143 | 60,000 | 82 | 0.9 | <20% | 140° | Yes | Enclosed | ✓ | ✓ |
| 36708 | 14PLL/840/EXT | 40W | 120-277V | 14 | 2,200 | 4000K | 157 | 60,000 | 82 | 0.9 | <20% | 140° | Yes | Enclosed | ✓ | ✓ |
| 36710 | 19PLL/835/EXT | 40W | 120-277V | 19 | 2,600 | 3500K | 137 | 60,000 | 82 | 0.9 | <20% | 140° | Yes | Enclosed | ✓ | ✓ |
| 36711 | 19PLL/840/EXT | 40W | 120-277V | 19 | 2,800 | 4000K | 147 | 60,000 | 82 | 0.9 | <20% | 140° | Yes | Enclosed | ✓ | ✓ |

FOOTNOTES:
 * This lamp might not be compatible with all dimmers. Please visit www.greencreative.com for compatibility information.
 ** Please visit www.greencreative.com for Limited Warranty terms
 Note: Factory setting at highest lumen output.

SUPPLIED ACCESSORY

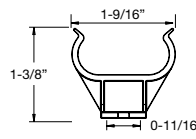
| Product | Model | Description | Picture | Dimension | Weight |
|---------|---------|--|---|---|--------|
| 98015 | PLLCLIP | Support clip with adhesive back for quick installation One support clip for each lamp included in the package |  |  | 0.08oz |

SYSTEM COMPATIBILITY

| COMPATIBILITY TABLE - LAMP & DRIVER | | | | |
|-------------------------------------|---|---|--------------------|--------------------------------------|
| Model | 15T8T5HEDRIVER/SD/2CH 15T8T5HEDRIVER/2CH/R | 15T8T5HEDRIVER/SD/4CH 15T8T5HEDRIVER/4CH/R | 24T5HODRIVER/2CH/R | 24T5HODRIVER/4CH/R |
| 13PLL/xxx/EXT | 1 lamp / 2 lamps | 1 lamp / 2 lamps / 3 lamps / 4 lamps | N.A. | N.A. |
| 14PLL/xxx/EXT | 1 lamp / 2 lamps | 1 lamp / 2 lamps / 3 lamps / 4 lamps | N.A. | N.A. |
| 19PLL/xxx/EXT | N.A. | N.A. | 1 lamp / 2 lamps | 1 lamp / 2 lamps / 3 lamps / 4 lamps |

Where xxx means 824-965 which indicates CRI and color temperature.



External Driver PLL

SYSTEM PERFORMANCE

LAMP & SelectDrive EXTERNAL DRIVER LUMEN OUTPUT GUIDE

| Product | Model | Lamp & Driver system lumen output | | | | | |
|---------|---------------|-----------------------------------|--------------|-----------------------|--------------|--------------|---------------|
| | | 15T8T5HEDRIVER/SD/2CH | | 15T8T5HEDRIVER/SD/4CH | | | |
| | | Low (Power) | Low (Lumens) | Med (Power) | Med (Lumens) | High (Power) | High (Lumens) |
| 36704 | 13PLL/835/EXT | 8.8 | 1,200 | 10.5 | 1,450 | 13 | 1,800 |
| 36705 | 13PLL/840/EXT | 8.8 | 1,300 | 10.5 | 1,600 | 13 | 2,000 |
| 36707 | 14PLL/835/EXT | 9.4 | 1,300 | 11.2 | 1,600 | 14 | 2,000 |
| 36708 | 14PLL/840/EXT | 9.4 | 1,450 | 11.2 | 1,750 | 14 | 2,200 |

DIMENSION & WEIGHT

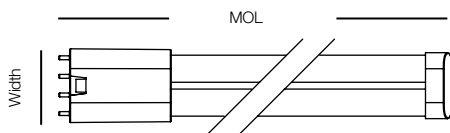

| Model | Base | MOL | Width | Weight |
|---------------|------|----------|----------|---------|
| 13PLL/xxx/EXT | 2G11 | 16-7/16" | 1-11/16" | 0.30 lb |
| 14PLL/xxx/EXT | 2G11 | 22-1/2" | 1-11/16" | 0.37 lb |
| 19PLL/xxx/EXT | 2G11 | 22-1/2" | 1-11/16" | 0.37 lb |

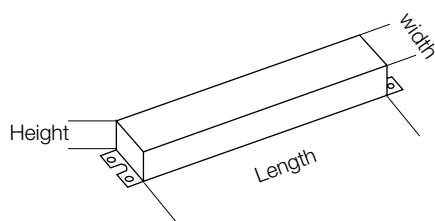

| Product | Model | Length | Width | Height | Weight |
|---------|-----------------------|--------|---------|---------|--------|
| 98259 | 15T8T5HEDRIVER/2CH/R | 9-1/2" | 1-5/16" | 1-3/16" | 1.0 lb |
| 98260 | 15T8T5HEDRIVER/4CH/R | | | | |
| 35896 | 15T8T5HEDRIVER/SD/2CH | | | | |
| 35897 | 15T8T5HEDRIVER/SD/4CH | | | | |
| 98261 | 24T5HODRIVER/2CH/R | 9-1/2" | 1-3/4" | 1-3/16" | 1.4 lb |
| 98262 | 24T5HODRIVER/4CH/R | | | | |

INSTALLATION

EXTERNAL DRIVER INSTALLATION

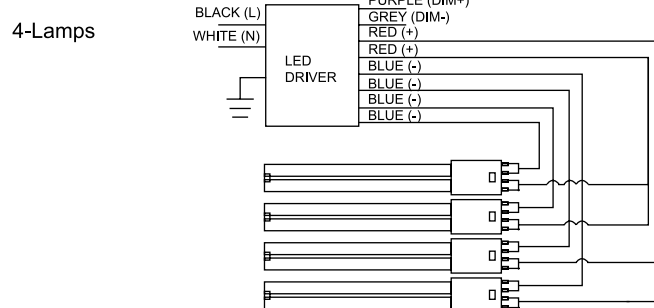
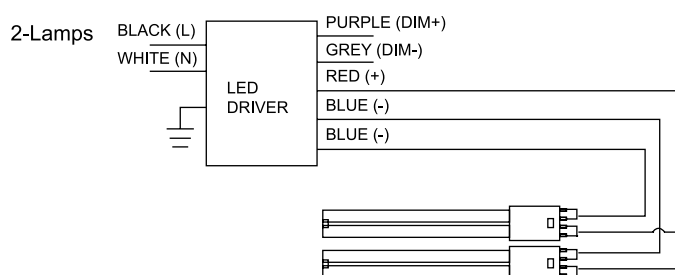
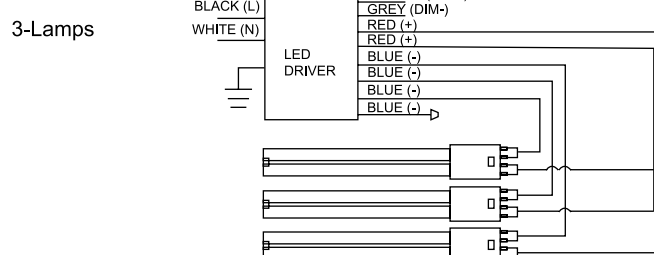
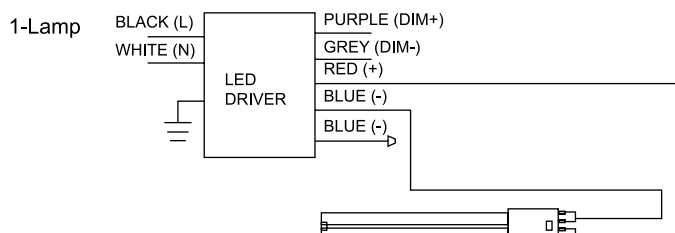

Note: All rights reserved. All sizes and specifications are subject to change at any time without notice.

External Driver PLL

INSTALLATION





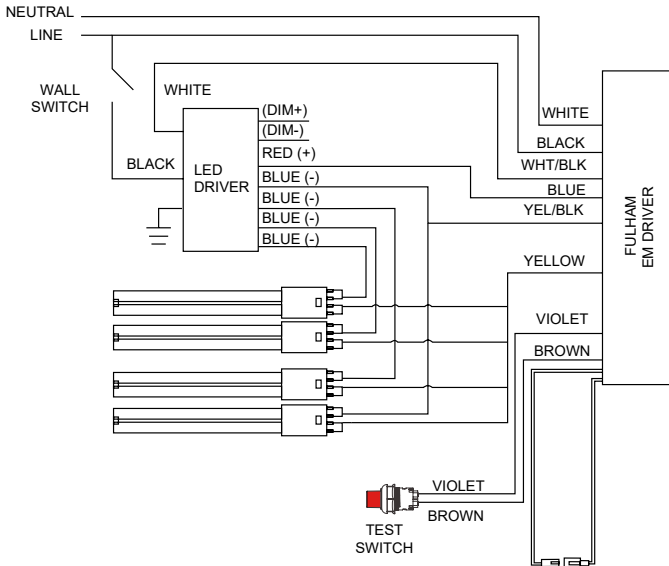

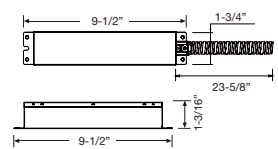

FULHAM EMERGENCY DRIVER INSTALLATION

Max 4 LAMPS

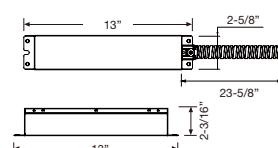

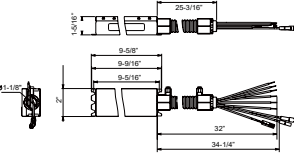
| COMPATIBILITY WITH FULHAM EMERGENCY DRIVER | | | |
|--|------------------------------|-------------------------------|--|
| Type | FULHAM EM DRIVER Model No | Lumen output level at EM mode | |
| | | FHSCP-UNV3-10W-LSD-A | FHSCP-UNV-17WL FHSCP-UNV3-15W-LSD-A |
| PLL | 13PLL/8XX/EXT | 87% | 135% |
| | 14PLL/8XX/EXT | 79% | 124% |
| | 19PLL/8XX/EXT | 62% | 96% |

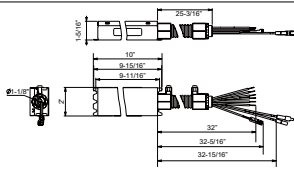
ACCESSORY ORDERING INFORMATION

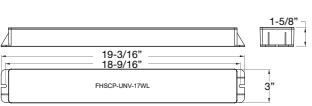
| Product | Model | Description | Pictures | Dimensions | Compatible Skus |
|-----------------------|-----------------------|---|---|--|---|
| 37934 | 8EMINVERTER | California Title 20 Compliant 8W Emergency LED Inverter (Field Installation) |  |  | 13PLL/8xx/EXT 14PLL/8xx/EXT 19PLL/8xx/EXT |
| 38096 | 24EMINVERTER | California Title 20 Compliant 24W Emergency LED Inverter (Field Installation) |  |  | 13PLL/8xx/EXT 14PLL/8xx/EXT 19PLL/8xx/EXT |
| FHSCP-UNV3-10W-L-SD-A | FHSCP-UNV3-10W-L-SD-A | 10W EM Driver 100-347V California Title 20 Compliant (Field Installation) |  |  | 13PLL/8xx/EXT 14PLL/8xx/EXT 19PLL/8xx/EXT |
| FHSCP-UNV3-15W-L-SD-A | FHSCP-UNV3-15W-L-SD-A | 15W EM Driver 100-347V California Title 20 Compliant Field Installation |  |  | 13PLL/8xx/EXT 14PLL/8xx/EXT 19PLL/8xx/EXT |
| FHSCP-UNV-17WL | FHSCP-UNV-17WL | 17W EM Driver 120-277V California Title 20 Compliant (Field Installation) |  |  | 13PLL/8xx/EXT 14PLL/8xx/EXT 19PLL/8xx/EXT |



External Driver PLL

EXTENDED WARRANTIES**

| Model | Description*** |
|--------------------------|---------------------------------------|
| 13PLL/EXT/10YEARWARRANTY | 10 Year warranty for 13PLL/8xx/EXT/yy |
| 14PLL/EXT/10YEARWARRANTY | 10 Year warranty for 14PLL/8xx/EXT/yy |
| 19PLL/EXT/10YEARWARRANTY | 10 Year warranty for 19PLL/8xx/EXT/yy |

FOOTNOTES:

** Warranty based on a maximum of 4,368 annual operating hours (per year for ten years) and exposure to a maximum fixture operating temperature of 80°F / 27°C.

*** xx - Refers to the CCT yy - Refers to model generations within the same nominal performance. Typically blank, 'R', or 'RC'

LOGISTIC INFORMATION

| Model | Master Carton | | | Shipping Carton | | |
|---------------|---------------|-----------------------------|-------------|-----------------|------------------------------|-------------|
| | Case Qty | Case Dimensions (LxWxH) | Case Weight | Case Qty | Case Dimensions (LxWxH) | Case Weight |
| 13PLL/xxx/EXT | 6PCS | 19-3/16" x 4-3/8" x 3-9/16" | 3lb | 24PCS | 19-15/16" x 9-7/16" x 7-7/8" | 13lb |
| 14PLL/xxx/EXT | 6PCS | 25" x 4-3/8" x 3-9/16" | 3.5lb | 24PCS | 25-7/8" x 9-7/16" x 7-7/8" | 15.5lb |
| 19PLL/xxx/EXT | 6PCS | 25" x 4-3/8" x 3-9/16" | 3.5lb | 24PCS | 25-7/8" x 9-7/16" x 7-7/8" | 15.5lb |

Where xxx means 824-965 which indicates CRI and color temperature.

CERTIFICATION INFORMATION

DLC KITS REFERENCES

| Model No. (DLC) | Lamp Model | Lamp Qty | External Driver Model | DLC Product ID |
|---------------------|------------------------|----------|--------------------------------|----------------|
| 14PLL/835/EXT/A2/R | 36707 14PLL/835/EXT | 2 | 98259 15T8T5HEDRIVER/2CH/R | S-C3T2GF |
| 14PLL/835/EXT/SD/A2 | | | 35896 15T8T5HEDRIVER/SD/2CH | PM6ZV7JJ |
| 14PLL/835/EXT/A3/R | | 3 | 98260 15T8T5HEDRIVER/4CH/R | S-401BY6 |
| 14PLL/835/EXT/SD/A3 | | | 35897 15T8T5HEDRIVER/SD/4CH | PIIW8SF8 |
| 14PLL/840/EXT/A2/R | 36708 14PLL/840/EXT | 2 | 98259 15T8T5HEDRIVER/2CH/R | S-9TR6E5 |
| 14PLL/840/EXT/SD/A2 | | | 35896 15T8T5HEDRIVER/SD/2CH | PI76P6D9 |
| 14PLL/840/EXT/SD/A3 | | 3 | 35897 15T8T5HEDRIVER/SD/4CH | PFCWFMNW |
| 14PLL/840/EXT/A3/R | | | 98260 15T8T5HEDRIVER/4CH/R | S-4RA78I |
| 19PLL/835/EXT/A2/R | 36710 19PLL/835/EXT | 2 | 98261 24T5HODRIVER/2CH/R | S-017W6L |
| 19PLL/835/EXT/A3/R | | 3 | 98262 24T5HODRIVER/4CH/R | S-S9T24R |
| 19PLL/840/EXT/A2/R | 36711 19PLL/840/EXT | 2 | 98261 24T5HODRIVER/2CH/R | S-0JDNLU |
| 19PLL/840/EXT/A3/R | | 3 | 98262 24T5HODRIVER/4CH/R | S-PUIN1R |