

Project Name:	Type:
Part Number:	Date:

3N1 9" SURFACE MOUNT

SPECIFICATION FEATURES

- **Mechanical** - Die cast aluminum heat sink. Polycarbonate trim. Smooth diffuse polycarbonate lens. Galvanized steel bracket mounts to industry standard 4" junction boxes from below the ceiling.
- **Electrical** - Universal 120-277V or 120V only, 50/60 Hz drivers available. Universal voltage, 0-10V drivers are dimmable to 5%. 120V drivers are dimmable to 10% using TRIAC or ELV dimmers.
- **Optical** - Edge lighting technology featuring a PMMA light guide plate and smooth polycarbonate lens ensures an even light emitting surface. 110° beam angle. Using SelectKelvin technology, field select color temperature between 3000K/3500K/4000K with a minimum of 90 CRI.
- **Thermal** - Die cast heat sink maximizes passive thermal management and achieves a L70 rated lifetime of 50,000 hours. Ambient temperature rated from -22°F to 95°F (-30°C to 35°C).
- **Compliance and Warranty** - ETL Classified and Listed for wet locations. Certified air-tight per ASTM 283-04. IC Rated for direct contact with insulation. Complies with FCC 47CFR Part 15B consumer limits for EMI/RFI emissions. Compliant with NFPA® 70, NEC® Section 410.16 (A)(3) and 410.16 (C)(5). 5 year parts warranty for complete fixture.



122724



BENEFITS

- Installs almost anywhere with Air-Tight, IC and Wet Location ratings
- Three mounting options, with J-box, recessed housing or direct ceiling
- Field selectable CCT
- 0-10V or 120V dimmable

APPLICATIONS

- Commercial – Offices, Common Areas, Vestibules, Storage Closets
- Residential – Bathrooms, Laundry Rooms, Kitchens, Closets, Garages
- Hospitality – Hallways, Bathrooms, Bedrooms, Storage Rooms

ORDERING INFORMATION

Series	Size	CRI	CCT	Dimming
<input checked="" type="checkbox"/> 3N1 3 N 1	<input checked="" type="checkbox"/> 9 9" 1250lm	<input checked="" type="checkbox"/> 90 CRI 90	<input checked="" type="checkbox"/> CCTS Selectable CCT 3000/3500/4000K	<input type="checkbox"/> DIM120V 120V Forward and Reverse Phase Dimming <input type="checkbox"/> DIM010UNV Universal 120-277V, 0-10V dimming

Note: Factory setting at 3500K CCT.

LINE DRAWINGS

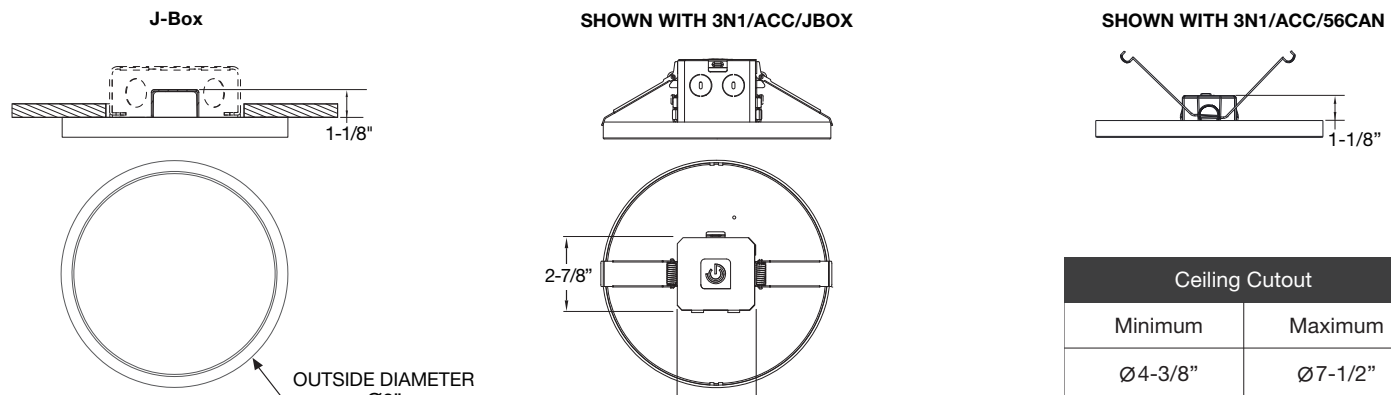

3N1 9" SURFACE MOUNT

INSTALLATION METHODS

Junction Box Mount

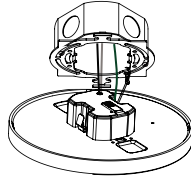

5/6" Recessed Housing

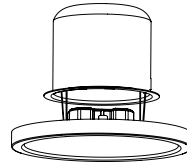

Direct Ceiling Mount

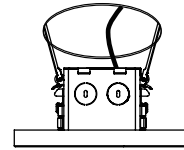

TECHNICAL INFORMATION

Dimming	Input Voltage	Input Frequency	Input Current	Input Power	THD Power	Power Factor
DIM120V	120V	50 / 60Hz	0.127A max	16.5W	<20%	>0.9
DIM010VUNV	120V	50 / 60Hz	0.125A max	16.5W	<20%	>0.9
	277V		0.062A max			

PHOTOMETRY

3N1/9/90/CCTS/DIM120V (3500K Selected)

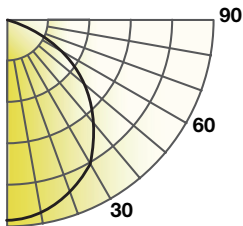

Lumens: 1,314 lm
 CBCP: 454 cd
 Power: 16.5 W
 Efficacy: 80 lm/W
 CRI: 90+
 Spacing Criteria: 1.26
 Beam Angle: 113°

Candlepower Distribution	
Angle (°)	Average (cd)
10	453
20	425
30	388
40	337
50	276
60	201
70	124
80	52
90	0

Initial Footcandles		
Height (ft)	Fc	Diameter (ft)
8	11	24.4
10	7	30.4
12	5	36.5
14	3	42.6
16	3	48.7

Zonal Lumen Summary		
Zone	Lumens	%Fixture
0-30	355	27%
0-40	583	45%
0-60	1,033	79%
0-90	1,314	100%

3N1/9/90/CCTS//DIM010UNV (3500K Selected)

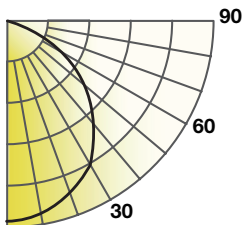

Lumens: 1,277 lm
 CBCP: 440 cd
 Power: 15.2 W
 Efficacy: 84 lm/W
 CRI: 90+
 Spacing Criteria: 1.28
 Beam Angle: 114°

Candlepower Distribution	
Angle (°)	Average (cd)
10	439
20	412
30	377
40	328
50	267
60	196
70	122
80	52
90	0

Initial Footcandles		
Height (ft)	Fc	Diameter (ft)
8	10	24.8
10	7	31.0
12	5	37.2
14	3	43.4
16	3	49.6

Zonal Lumen Summary		
Zone	Lumens	%Fixture
0-30	344	27%
0-40	566	45%
0-60	1,004	79%
0-90	1,277	100%











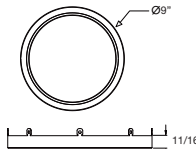

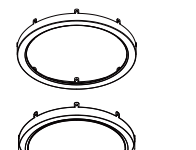

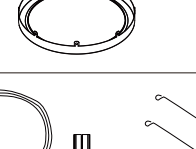
3N1 9" SURFACE MOUNT

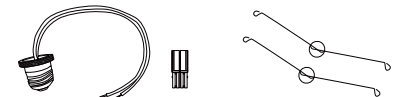
NOMINAL PERFORMANCE

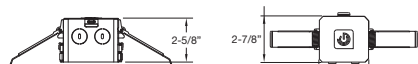
3N1/9/90/CCTS/DIM/xxxx						
CCT	3000K		3500K		4000K	
Dimming	120V Dimming	0-10V	120V Dimming	0-10V	120V Dimming	0-10V
Output	15.9W	16.2W	16.5W	15.2W	16.1W	15.4W
Lumens	1,278	1,206	1,314	1,277	1,333	1,285
LPW	80	75	80	84	83	84

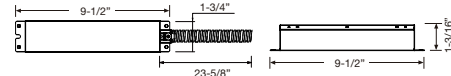
ACCESSORY ORDERING INFORMATION

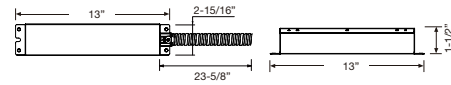
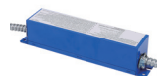
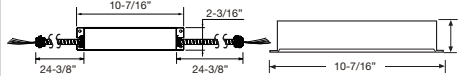
Product	Model	Description	Pictures	Dimensions
35475	3N1/TRM/9/BL	9" 3N1 - Black Trim		
35476	3N1/TRM/9/BZ	9" 3N1 - Bronze Trim (Not for use outdoor)		
35477	3N1/TRM/9/BN	9" 3N1 - Brushed Nickel Trim (Not for use outdoor)		
35479	3N1/ACC/56CAN	5-6" Can Installation Accessories		
35480	3N1/ACC/JBOX	Direct Mount Accessory J-Box		
37934	8EMINVERTER	California Title 20 Compliant 8W Emergency LED Inverter (Field Installation) Not compatible with 120V dimming models		
37935	21EMINVERTER	California Title 20 Compliant 21W Emergency LED Inverter (Field Installation)		
98003	23EMDRIVER	California Title 20 Compliant 23W Emergency LED Driver (Field Installation)		

ORDERING GUIDE

Product	Model
35464	3N1/9/90/CCTS/DIM120V
35468	3N1/9/90/CCTS/DIM010UNV

Note: All rights reserved. All sizes and specifications are subject to change at any time without notice.