

# T8 10.5W 3FT. EXT TITANIUM LED SERIES



PRO



EXTERNAL DRIVER

10.5W REPLACES



25W  
Fluo.

60% Energy Savings

- Compatible with GREEN CREATIVE external drivers only
- Suitable for use with shunted & non-shunted lamp holders
- Exceptional efficacy 152 LPW
- Suitable for use in totally enclosed fixtures
- Frosted glass design - Meets NSF requirements
- 0-10V dimming



50,000 H



DIMMABLE



UNIVERSAL



WARRANTY

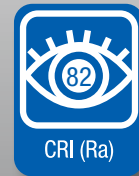

CRI (Ra)

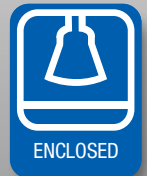

ENCLOSED



## TUBE FEATURES

External Driver - 1-2 & 3-4 Lamp Versions



These lamps are designed for use with GREEN CREATIVE external drivers only. These 0-10V dimmable drivers are available in 1-2 lamp and 3-4 lamp versions and are compatible with GREEN CREATIVE T8 4', 3' and 2' EXT lamps.

Extra Wide Beam Design - Frosted Glass Body

This lamp uses an innovative glass design that diffuses heat and light more evenly. As a result of its compact light engine, this lamp produces a light emitting area of 310°. This wider beam angle improves a fixture's total light distribution and creates a more complete lighting effect.



Lamp Front View

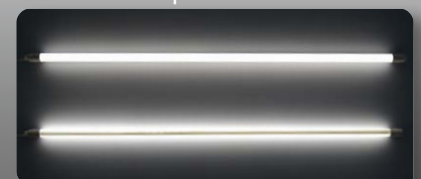

Lamp Back View

# T8 10.5W 3FT. EXT TITANIUM LED SERIES



## SPECIFICATIONS

Product Model	98328 10.5T8/3F/830/EXT	98329 10.5T8/3F/835/EXT	98330 10.5T8/3F/840/EXT
Type	T8	T8	T8
Base	Medium Bi-Pin G13	Medium Bi-Pin G13	Medium Bi-Pin G13
Lamp Power (W)	10.5	10.5	10.5
System Power (W)	12.5	12.5	12.5
Voltage - Frequency	120-277V 50-60Hz	120-277V 50-60Hz	120-277V 50-60Hz
Color Temp. (ANSI)	Warm White 3000K	Neutral White 3500K	Cool White 4000K
CRI (Ra)	82	82	82
Typical lumens (lm)	1450	1500	1600
Efficacy (LPW)	138	143	152
System Efficacy (LPW)	116	120	128
Light Emitting Area	310°	310°	310°
Beam Angle	160°	160°	160°
Dimmable	Yes	Yes	Yes
Power Factor	0.9	0.9	0.9
THD	<20%	<20%	<20%
Rated Lifetime - L70 (hrs.)	50,000	50,000	50,000
Temperature Rating	-4°F / -20°C - 95°F / 35°C	-4°F / -20°C - 95°F / 35°C	-4°F / -20°C - 95°F / 35°C
Dia. x MOL	1.14" x 35.75" (29 x 908mm)	1.14" x 35.75" (29 x 908mm)	1.14" x 35.75" (29 x 908mm)
Weight (lb. / g)	0.4lb. / 181g	0.4lb. / 181g	0.4lb. / 181g

## EXTERNAL DRIVER SPECIFICATIONS

Product Model	98259 15T8T5HEDRIVER/2CH	98260 15T8T5HEDRIVER/4CH
Number of lamps	1-2	3-4
Input Voltage - Frequency	120-277V 50-60Hz	120-277V 50-60Hz
Max. Input Current (A)	0.31	0.64
Max. Input Power (W)	37	75
Output Voltage (V)	DC 30-50	DC 30-50
Output Current (A)	0.3 * 2	0.3 * 4
Dimmability	0-10V	0-10V
Temperature Rating	-4°F / -20°C - 95°F / 35°C	-4°F / -20°C - 95°F / 35°C
Max Case Temperature	185°F / 85°C	185°F / 85°C
Case Dimension (LxWxH)	9.5"x1.3"x1.2" (241x33x30mm)	9.5"x1.3"x1.2" (241x33x30mm)

## EXTERNAL DRIVER & LED TUBE COMBINATION

			98259				98260							
			15T8T5HEDRIVER/2CH								15T8T5HEDRIVER/4CH			
			1 Lamp		2 Lamps		3 Lamps		4 Lamps					
Product	Model	Color Temp. (ANSI)	System Power (W)	Typical Lumens (lm)	System Power (W)	Typical Lumens (lm)	System Power (W)	Typical Lumens (lm)	System Power (W)	Typical Lumens (lm)				
98328	10.5T8/3F/830/EXT	3000K	12.5	1450	25	2900	37.5	4350	50	5800				
98329	10.5T8/3F/835/EXT	3500K	12.5	1500	25	3000	37.5	4500	50	6000				
98330	10.5T8/3F/840/EXT	4000K	12.5	1600	25	3200	37.5	4800	50	6400				

Ref.#: DS300 - T8-10.5W-3FT-EXT-250618

## EXTERNAL DRIVER INSTALLATION

### Double-ended Installation

- For shunted & non-shunted lamp holders
- Not polarity sensitive, lamps can be wired at either end

#### 1 Lamp

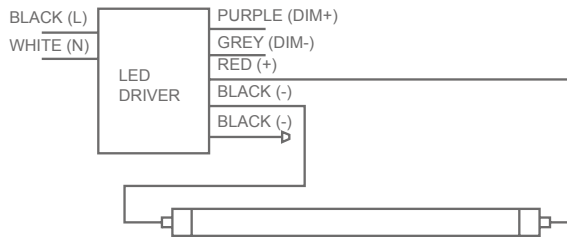

#### 4 Lamps

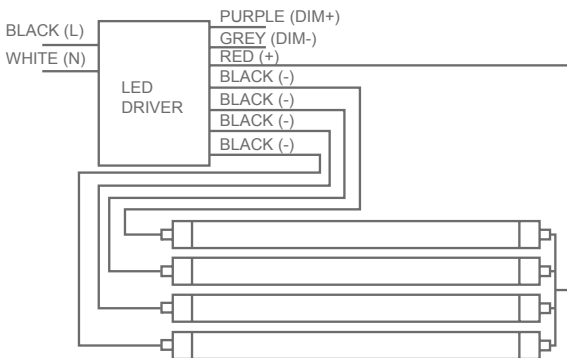

### Single-ended Installation

- For non-shunted lamp holders only
- Not polarity sensitive, lamps can be wired at either end

#### 1 Lamp

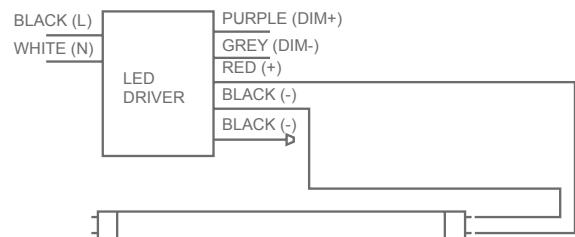

#### 4 Lamps

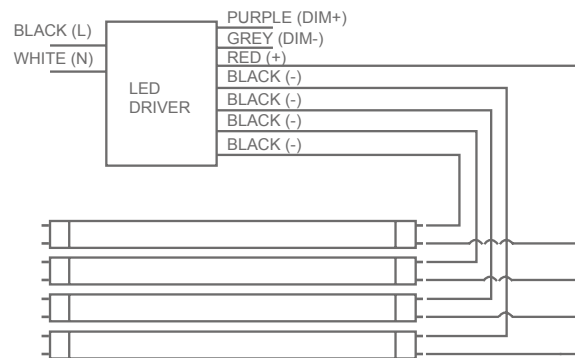

\* Suitable for use in totally enclosed fixtures

\*\* Suitable for damp locations. Not for use where directly exposed to the weather or water

\*\*\* Full installation guide and more details available on website